

QNAP

Turbo NAS

TS-x53 Pro/SS-x53 Pro Series

Ideal Solutions for SMBs to Build a Private Cloud

Celeron® quad-core 2.0GHz SoC CPU, burst up to 2.41GHz



Use your NAS as a PC



- Use your NAS as a PC with QvPC Technology
- Manage, share, and back up business data
- Real-time Remote Replication (RTRR) and cloud-based storage backup
- NAS and iSCSI-SAN unified storage solution
- Enhanced data security with high-performance AES 256-bit encryption and anti-virus
- Supports VMware®, Citrix®, and Microsoft® Hyper-V and advanced virtualization features
- Operate multiple Windows, Linux and Android-based virtual machines with the integrated Virtualization Station
- On-the-fly and 4K offline full HD hardware accelerated video transcoding



TS-253 Pro

TS-453 Pro

TS-653 Pro

TS-853 Pro

SS-453 Pro

SS-853 Pro

Powerful, Reliable and Scalable NAS Solutions for SMBs

The TS-x53 Pro/ SS-x53 Pro Series, featuring the easy-to-use QTS operating system, is a powerful, reliable, secure and scalable NAS solution designed for mission-critical business applications and fast growing data storage needs. The TS-x53 Pro/ SS-x53 Pro Series delivers high performance with persistent throughput, providing a comprehensive storage solution for SMBs to build a reliable private cloud. Powered by a cutting-edge 22nm quad-core Intel® Celeron® 2.0GHz processor with 2/4/8GB energy-efficient DDR3L RAM (upgradable to 8GB), the TS-x53 Pro/ SS-x53 Pro Series is a powerful NAS that delivers up to 400MB/s read & write speeds. The TS-x53 Pro/SS-x53 Pro Series can also automatically increase its processor's clock rate from 2.0GHz to 2.41GHz when needed for CPU-intensive tasks. With QNAP's exclusive integrated QvPC technology, TS-x53 Pro/SS-x53 Pro Series is the world's first NAS that can be transformed into a cost-effective PC substitute for business applications.



QvPC Technology



Built-in VMs



Hardware Accelerated Transcoding



QNAP received ISO 27001 certification for information security management



Table of Contents

QvPC Technology	1
About QvPC Technology	
Highlights of QvPC Technology	
Virtualization Station	7
Multi-purpose on a machine (Virtualization Station)	
Transcoding Center	11
QNAP's Unique Transcoding Technology	
QTS 4.1 OS	13
Intuitive & simple design	File management
Customized login page	Qsync
Data security	Unified storage and virtualization applications
NAS connection and network setting	IT Management Station
Uninterruptible Power Supply (UPS)	Signage Station
File backup/Disaster recovery	Surveillance Station
Security management	
Application Server	
myQNAPcloud SmartLink	
App Center & developers	41
App Center	
Third-party Development Platform	
TS-x53 Pro / SS-x53 Pro series hardware introduction	47
Features	
QNAP USB 3.0 JBOD	
Hardware specifications	

Powered by QNAP's exclusive QvPC Technology

■ About QvPC Technology

Based on Software-defined Everything, QvPC Technology is the result of years of R&D effort that QNAP has put into developing and perfecting its software and hardware expertise. QvPC Technology has consolidated a number of high-end technologies and latest IT trends including VM integration, multimedia transcoding, HDMI output, cloud integration, and NAS connection technologies, allowing users to operate TS-x53 Pro/SS-x53 Pro as a PC when they plug in a keyboard, mouse and monitor. QvPC Technology can turn a NAS into a low-cost & high-performance 2-in-a box NAS that can function as a NAS and a PC. Whether you are working in a studio or at a remote site, you are assured to receive the best user experience.

QvPC Technology features HybridDesk Station (HD Station) as the user interface, which consists of QVM Desk, Defense Desk, and Local Display Desk and provides SMBs various software applications.

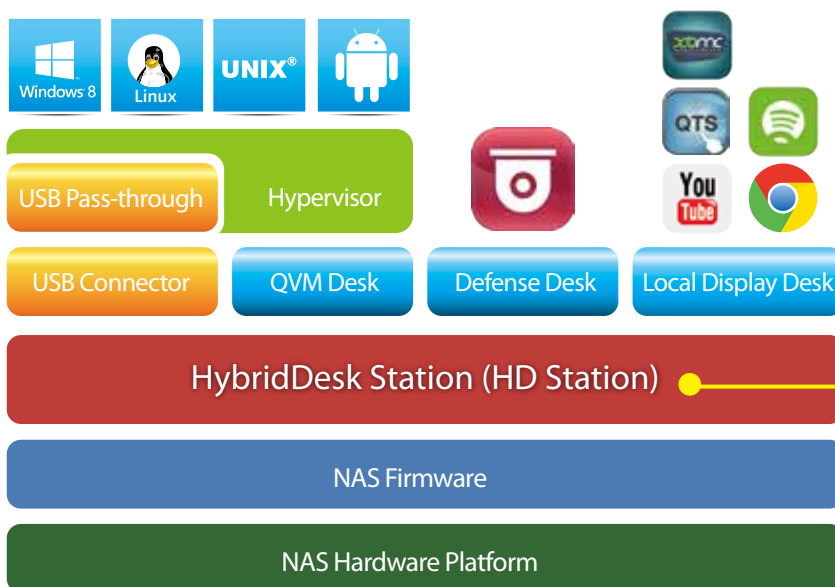

Connect a monitor with HDMI, and you can enjoy a variety of applications with HD Station. You can initiate the service in QTS system and install different applications according to your needs.



* All trademarks in this brochure are the property of their respective owners.



The highlights of QNAP's exclusive QvPC Technology

Technology

- HybridDesk Station (HD Station)

HD Station is a monitor-based user interface based on QNAP's exclusive QvPC Technology. Simply plug in a keyboard, mouse, and HDMI monitor to a TS-x53 Pro/SS-x53 Pro, and you can start the installation process and access data without connecting to a PC, tablet, or smartphone. A variety of local display applications are available on HD Station including QTS, Google Chrome, QVM, XBMC, and Surveillance Station.



HD Station is touchscreen enabled*. Simply plug in a touchscreen monitor and start using it immediately.

- Streamlined installation*: No complicated procedures necessary to install your NAS.

After purchasing a NAS, users usually install firmware from an installation disc and search for the NAS on their network, or log in to the NAS manufacturer's website to complete the installation process. For users without relevant networking knowledge, this installation process may be difficult. Some users decide to purchase other external storage devices that can be instantly access (such as USB hard drives). However, these devices are "islands of information" that can only be accessed by the computer they are connected to. These storage solutions also have no protection against failure, and can be easily lost.

NAS is an ideal solution for storing data. With QvPC Technology users only need to plug in a HDMI monitor, keyboard, mouse and follow on-screen instructions to complete their NAS installation. Even users without any network knowledge can easily set up and install a NAS. All files stored on a NAS are protected with RAID technology and are accessible via the Internet anytime.

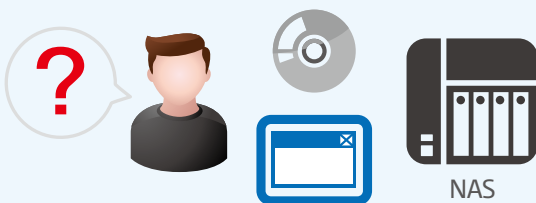

Conventional installation: You need an disc or to login to a website to complete the installation, and it can be complicated for general users

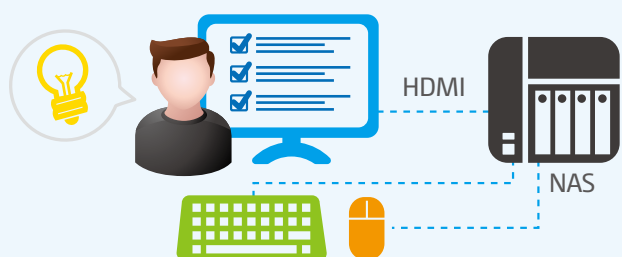

Streamlined installation: simply plug in a monitor, keyboard and mouse and you can quickly complete the on-screen instructions to complete the installation.

*Available in QTS 4.1.2

QvPC Technology

- QNAP QVM Desk turn a NAS into an office PC



Run Windows, Linux and Android* virtual machines on a HDTV

Leveraging virtualization technology, QNAP QVM Desk supports local display for a virtual interface and turns the NAS into a PC when connected to a HDMI monitor, keyboard, and mouse. Any files on the TS-x53 Pro/SS-x53 Pro can be opened using virtual machines running Windows, Android*, Linux, and Unix through QVM Desk. You can also instantly switch between different virtual machines to meet your needs, just like using multiple PCs at the same time. Compared to the operations via a webpage, it's smoother, more secure, and worry-free to do on a NAS. Even when the Internet connectivity is limited, you can still access data and run virtual machines on a NAS.



*Available in QTS 4.1.2

Run Android on a NAS with QvPC*

Have you ever constricted by the lack of storage space on your tablet or smartphone with no idea where to backup your files or what apps to delete for more space? With QvPC Technology, you can run Android on a virtual machine, and back up apps or files like LINE, WeChat, Gmail, your phonebook, photos, and chat messages from your Android device to the virtual machine with backup software like App Backup & Restore and My Backup Pro. This way, the files on the public cloud can be stored on your private cloud. You no longer need to worry about having difficulty accessing your data anymore. In addition, your NAS can be transformed to an Android device and the millions of apps on Google Play can be operated on it as well.

*Available in QTS 4.1.2



LINE

WhatsApp

Gmail

Facebook



To learn more about QNAP Virtualization Station, please turn to Page 7.

QvPC Technology



■ Defense Desk* 24/7 Safeguard your office and property

Surveillance Station is the monitoring center for your office

Live-view

QvPC Technology supports local display of live surveillance feeds on the screen with a QNAP remote control. You don't need an additional PC for live-view, nor do you need an Internet connection to check the stored video recordings. You can monitor up to 16 channels simultaneously, adjust PTZ functions, and conduct audio surveillance. QvPC also supports instant notification functions and will show alerts on the monitored page should any incident happens, helping you take immediate action and control the work environment more efficiently.



Playback

You can connect your NAS to a monitor to playback recordings. Just select a timeframe, and you can search the recordings within this period. It also supports video fast-forwarding and rewinding (up to 16x speed). You can quickly look for detailed images with the zoom function, and listen to audio for key background sounds during the playback.



To learn more about QNAP Surveillance Station, please turn to Page 39.

■ Manage Local Display Desk easily



Quickly install* QTS and access files

Just plug in a HDMI monitor/TV, keyboard and mouse to a TS-x53 Pro/SS-x53 Pro, and within a few simple steps you will complete installation and be able to access files using the QTS operating system.

*Available in QTS 4.1.2





Surf the web via Chrome on TV

QvPC Technology supports HDMI-out and Google Chrome, allowing you to surf the web easily, and is ideal for offices to build a information search center with minimal costs.



Build an online music center with Spotify*

Over a million songs can be found on Spotify. Create a media center and enjoy your music collections with your NAS while at work.



QNAP Remote Control (RM-IR002)

*Available in QTS 4.1.2



Qremote mobile app turns your mobile device into a handy remote control

iOS and Android users can download the Qremote app to turn their smartphones into a remote control to conveniently play videos, music, and photos on TV via HD Station. The Official XBMC Remote app can also be used.



Virtualization Station

Multi-purpose on a Machine (Virtualization Station)

- All-in-one NAS with multiple systems

The TS-x53 Pro/SS-x53 Pro Series is the world's first consumer-grade NAS that supports Intel VT-x and virtual machine applications. Just download the Virtualization Station App from App Center, and you can install & operate multiple operating systems with Windows, Linux, and UNIX. The virtual machines can be used in a variety of different ways to boost the functionality of your Turbo NAS, just like having multiple computers with you.

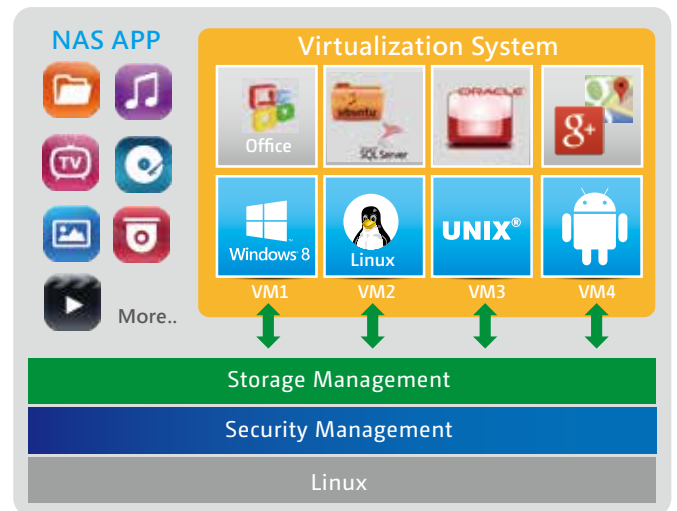

Virtualization technology is normally solely used in enterprise IT environments, but with the growing needs of a digital office, virtualization is slowly becoming part of our everyday applications. Many offices have printers, and when users want to print out the documents stored on their Turbo NAS, but have a printer with Windows-only drivers, they would need to startup their PC just for this simple task.

Creating multiple VMs on TS-x53 Pro/SS-x53 Pro.



To use Virtualization Station, we recommend that you upgrade the RAM of your NAS to at least 4GB, or you can directly purchase a TS-x53 Pro model with 8GB RAM or a SS-x53 Pro.

You can carry out the aforementioned scenario using the below steps.

- 1 Download Virtualization Station from the App Center and create a Windows-based VM
- 2 Install the printer drivers in the VM
- 3 Map the destination folder into the Windows-based VM, and set the folder as a network drive
- 4 Access the VM remotely via web browser to select a photo and then print it instantly



*The network usage of Virtualization Station is isolated from the Turbo NAS. One Ethernet cable is reserved for the Turbo NAS to use, so you will need to connect at least another one for the Virtualization Station to use.



How to map the destination folder into a Windows VM?
Please follow these steps: (Using Windows 7 as an example)

- A Go to "Computer" and click [Map network drive]
- B Please insert the IP address of your Turbo NAS and click [Browser]. Select the folder you want to use and click [Finish].
- C This folder you want to use will appear as a network drive on your "Computer"

■ USB devices supported (USB Passthrough)

QNAP Virtualization Station supports connecting USB devices to virtual machines. Commonly-used USB devices can be connected to virtual machines, and you can select what device to use with Virtualization Station.

This can be used together with QVM Desk just as easily as using a PC. For document management, you can connect USB card readers/scanners to NAS via Virtualization Station, and store scanned data directly to the NAS without taking up Internet bandwidth.



Virtualization Station

■ QNAP-exclusive virtualization technology highlights

Direct access to files & data via VM

Specific file formats cannot be opened directly by the Turbo NAS, but the Virtualization Station makes it possible. Administrators can install Windows, Linux, and UNIX on the Turbo NAS to run any supported application or file.



Save bandwidth & time

Downloading a large amount of data to a local PC has the potential to take a long time and use up network bandwidth. When accessing data on the Turbo NAS through virtual machines on the Virtualization Station, you can enjoy secure data transmission and save bandwidth & time as the data is not transmitted via physical network cables.

Enhance security and save bandwidth

When accessing files & data on a virtual machine they are not transmitted outside of the Turbo NAS. This provides a secure environment that prevents sensitive data from being intercepted and also saves bandwidth & network resources when you need to access large files.

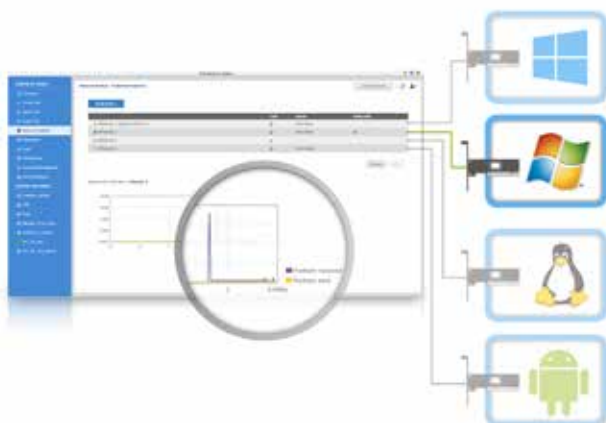

Dedicated network for VM only

The Virtualization Station provides functions for network monitoring. You can monitor all NIC (network interface controller) traffic and assign a specific NIC exclusively to a single VM.

User-based permissions settings

The Virtualization Station administrator can create users and set proper permissions for each Virtual Machine (VM), helping to efficiently manage and allocate VM resources for users with different needs. With these permissions, users can work independently on their VM without worrying about their work being interrupted or data being lost because another user has accidentally powered-off the VM.

User-based permissions include :

- Console permissions: Control and View-only
- VM controls: Power, Snapshot and Advanced

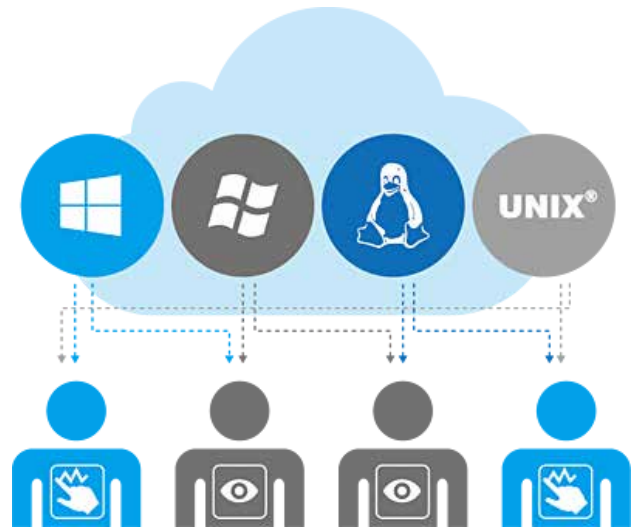

Auto Start



VM auto-start

VMs can be set to automatically start when the Turbo NAS restarts, allowing the applications on VMs not to be disrupted.



Operate VMs as Remote Desktops

Enjoy utmost convenience by operating Windows, Linux and UNIX-based VMs as remote desktops. A list of buttons is provided on the left side of each individual VM display, allowing users to suspend, shutdown, force shutdown, reset, bring up key combinations **Ctrl + Alt + Del** & function keys, and even take snapshots for the VMs.

QNAP QVM Desk

QNAP QVM Desk supports local display for deploying virtual applications on a big screen when connected to a HDMI monitor, keyboard, and mouse. Compared to webpage operations it's smoother, more secure, and worry-free to do on a NAS. Even when Internet connectivity is limited, you can still access data and run virtual machines on a NAS.



*Available in QTS 4.1.2

Transcoding Center



QNAP's Unique Transcoding Technology

Every year many SMBs produce hundreds of promotional videos for marketing purposes. However, due to the increasing use of HD videos (720p, 1080p), video files are becoming increasingly large in size and can use lots of network bandwidth to share or play them over a network.

Transcode Management

On-the-fly Transcoding and Background Transcoding allows you to convert videos to optimized resolutions for accommodating slower/restricted network environments and device limitations.



Why do we need transcoding?

With the popularity of high-definition smartphones and digital cameras, video resolutions are getting higher. A higher resolution means larger file sizes and more bandwidth needed to stream it. Transcoding creates videos with optimal resolutions for sharing & watching in order to save bandwidth, but also retains the unaltered original video on the Turbo NAS.

Smart transcoding adapts to suit different bandwidth

The TS-x53 Pro/ SS-x53 Pro Series provides a range of resolutions to play/share videos according to different bandwidth limits. Higher resolutions need more bandwidth, and you can select the right resolution for your network environment to get the best viewing experience.

Resolution \ Network	240p	360p	480p	720p	1080p	4K2K
Ethernet	[Icon]	[Icon]	[Icon]	[Icon]	[Icon]	[Icon]
Wi-Fi (108.11 ac)	[Icon]	[Icon]	[Icon]	[Icon]	[Icon]	[Icon]
Wi-Fi (108.11 a/b/n)	[Icon]	[Icon]	[Icon]	[Icon]	[Icon]	[Icon]
4G (LTE)	[Icon]	[Icon]	[Icon]	[Icon]	[Icon]	[Icon]
3G	[Icon]	[Icon]	[Icon]	[Icon]	[Icon]	[Icon]

Multi-mode transcoding function

Background hardware-accelerated transcoding

The TS-x53 Pro / SS-x53 Pro fully supports offline background transcoding for 1080p and 4K (H.264) videos. Just add videos to the transcoding list and use the Turbo NAS to convert the original high-resolution video for use with multiple resolutions. Then you can select an appropriate resolution when sharing or watching to match your device or network environment.



Auto transcoding

When you set a folder on the Turbo NAS to be an auto-transcoding folder, videos added to it will be automatically converted to a resolution you have set. For example, if you set the folder to 360p, videos added to this folder will be automatically transcoded to 360p as a background task.

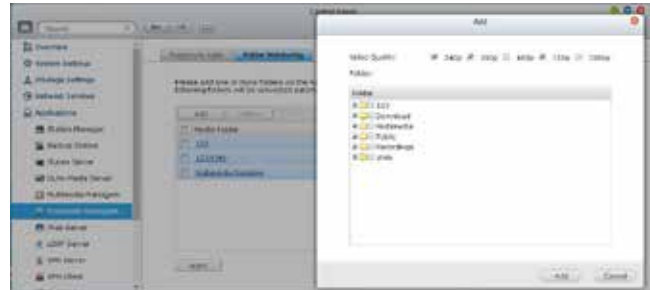

On-the-fly transcoding

If you have many high-resolution videos, but did not transcode in advance, you can use on-the-fly transcoding. This will adapt to meet bandwidth limits, with the Turbo NAS transcoding in real time for directly watching the video.



Hardware-accelerated transcoding technology

With Intel® HD Graphics, video creation & conversion is faster, easier and can significantly reduce the time needed when handling multiple on-the-fly transcoding tasks.

Performance

Compare the transcoding time between the TS-x53 Pro/ SS-x53 Pro and TS-x69 Pro with using the same high-resolution (1080p) video. Powered by an Intel Celeron CPU with QNAP's exclusive transcoding technology, the TS-453 Pro is 18 times faster than the Atom-based TS-469 Pro.



Hardware-accelerated transcoding is **18 times** faster than software transcoding.

QTS 4.1 OS

Intuitive & Simple

Based on Linux, QTS is designed to be simple and flexible while centralizing multiple applications efficiently in the App Center.

- › Multi-Window: Simultaneous multi-window operation for easy usage.
- › Multi-Task: Improve work efficiency by performing multiple tasks at the same time.
- › Multi-Device: Synchronize cross multiple devices anytime, anywhere.
- › Multi-App: Use a range of easy-to-manage apps and download more as needed.
- › Multi-Scenario: Customize your own cloud platform with multiple applications.

■ Intelligent Desktop

QTS 4.1's intelligent desktop offers an intuitive, sleek, and easy-to-follow graphic user interface that simplifies your Turbo NAS experience. It allows you to open multiple application windows and simultaneously run multiple tasks. Application windows can be minimized to the toolbar to allow you to see an overview of the opened applications and switch between running applications.



The screenshot shows the QTS 4.1 OS desktop environment. On the left is a vertical 'Main menu' containing application categories like 'APPLICATIONS' and 'SYSTEMS'. The desktop has several icons for applications like 'Control Panel', 'Photo Station', and 'Music Station'. A 'Smart toolbar' is located at the top right. A 'Smart dashboard' is overlaid on the desktop, displaying system health, storage status, and scheduled tasks. A 'Quick search' icon is visible in the bottom right corner.

Main menu
All of your applications, system preferences, and additional apps installed from the App Center are neatly presented for you to quickly find your desired app. Drag and drop frequently used icons to the desktop as shortcuts for easier access.

Multiple desktops
The extended desktop workspace is specifically designed to improve your productivity. You can move apps to different desktops according to their category and freely switch between them.

Smart toolbar
Background tasks
Displays all the active and scheduled tasks performed in the background.
External devices
Access connected storage devices and safely eject them with a single click.
Event notifications
Updates you with system information including warnings and other error messages.

Smart dashboard
In just one click the smart dashboard presents all the important system information in a single panel. Drag any status to the desktop for constant monitoring.

Quick search
Quickly search for system settings and QTS Help.

Customized Login Page

- Public photo wall and app shortcuts on the login page

Customize the photo wall based on your company image and display it on the login page. Each app has its own shortcut that you can place on the login page to allow direct access without the need to log into QTS first.

Enable this option and ...



Display the app shortcut on the login page.



App shortcuts become available

Customized admin photo

Public photo wall

QTS 4.1 OS

Data security

■ Privilege settings

You can create multiple user accounts and shared folders, and set user permissions for accessible shared folders with the support of system privilege settings and ACL advanced folder permissions.

■ Storage Manager

RAID configuration & management

The Turbo NAS supports comprehensive RAID configurations for better data protection. Based on the number of hard drives installed, administrators can choose from RAID 0, 1, 5, 6, 10, 5+hot spare, 6+hot spare, and 10+hot spare configurations. Considering needs for performance and extra redundancy, administrators can choose the most appropriate RAID configuration to reduce the risk of data loss from unexpected hard disk failures.

The Global Hot Spare feature allows shared spare drives with multiple RAID volumes on the Turbo NAS. When a hard drive fails in any RAID volume, the global hot-spare drive will automatically replace the failed drive to prevent data from being lost. Compared with a local spare drive, the Global Hot Spare function offers a more efficient use of spare drives.

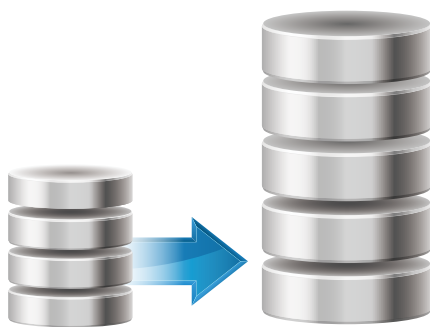
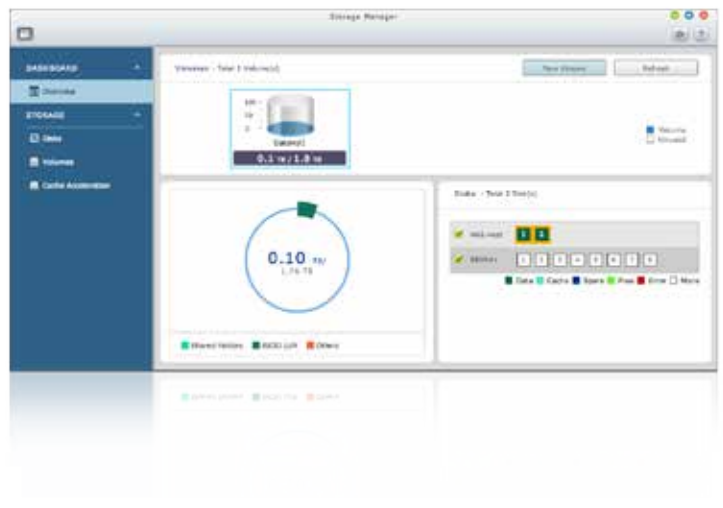
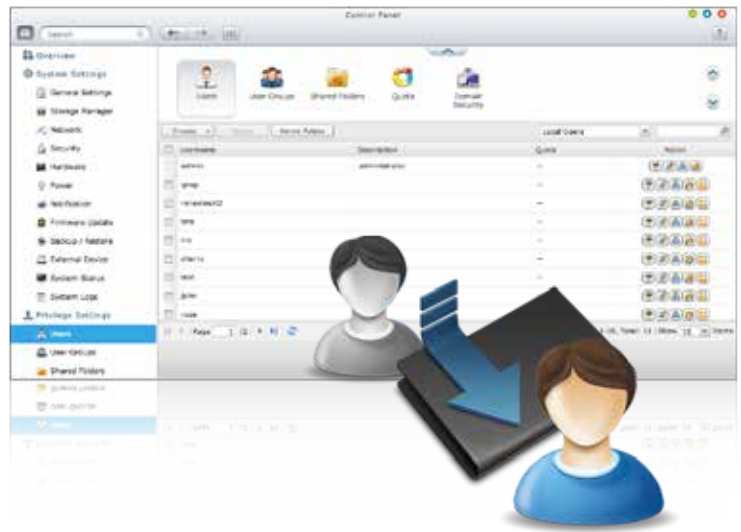

RAID 5

RAID 6

RAID volume expansion

The TS-x53 Pro / SS-x53 Pro makes RAID volume expansion convenient and easy. At initial setup, administrators can create RAID volumes by using small-sized hard drives, and replace the hard drives with larger ones anytime as the RAID volume expansion can be done easily with the Turbo NAS. All the actions of expanding the volume capacity can be done online, without turning off the server and with all the data retained.



You can install the Qmanager app on your mobile devices to conveniently manage & monitor your Turbo NAS anytime, anywhere.



Available on the App Store

Google play



NAS connection and network setting



- Qfinder for connecting to a NAS

Instant connection and NAS setup

Qfinder is a utility for Windows, Mac, and Linux that lets you quickly find and access the Turbo NAS over LAN. Install Qfinder on your computer, open it, and double click your Turbo NAS name and the login page is ready for you.

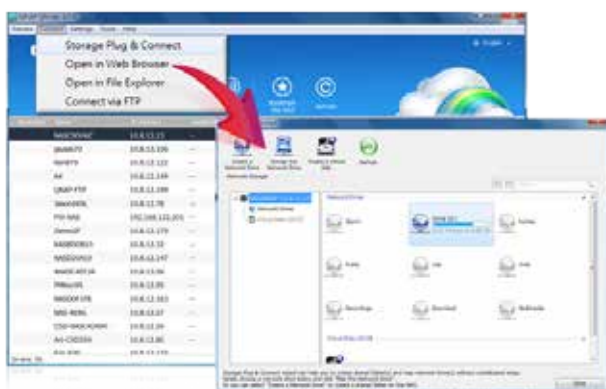
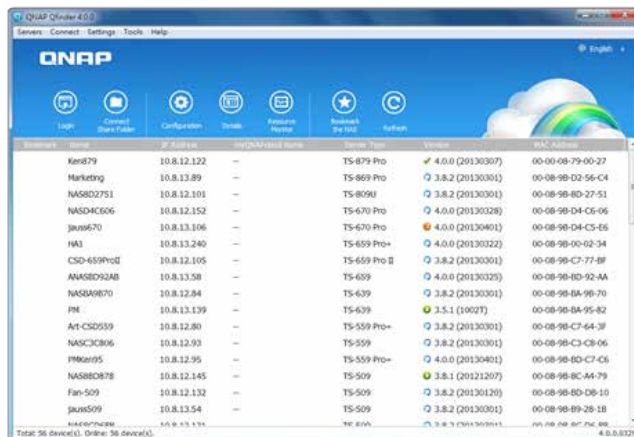

Easy access to NAS with Storage Plug & Connect

The Windows version of Qfinder provides a convenient way to connect to the Turbo NAS and map a network drive or virtual disk. By creating a shared folder on the Turbo NAS and mapping it as a network drive, you can use it as if it were a local drive on your computer.

- System network setup

TCP / IP and service connection setup

TS-x53 Pro / SS-x53 Pro offers 4 Gigabit LAN ports (TS-253 Pro / SS-453 Pro with 2 Gigabit LAN ports). You can click on the QTS [Control Panel] > [System Settings] > [Network] to activate service connection, assigning QTS applications to one or more network interfaces (over LAN or wireless). The NAS will allow application access based on IP sources to optimize the LAN ports utilization for your network environment.

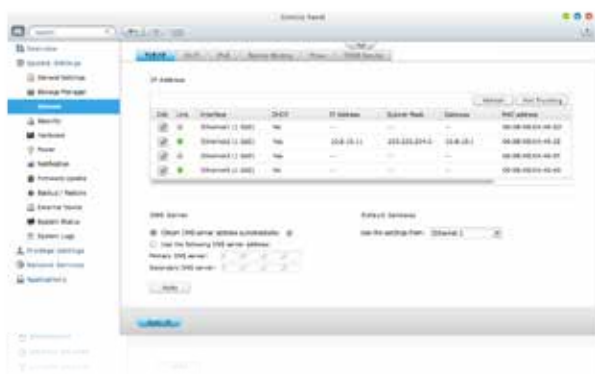

QTS 4.1 OS

Case study for 4 LAN ports arrangement

Optimize network resources with high security

TS-x53 Pro / SS-x53 Pro offers 4 Gigabit LAN ports (TS-253 Pro / SS-453 Pro with 2 Gigabit LAN ports), and you can assign each port for different applications to optimize network resources and increase security (for example: Public IP, Intranet, Server Backend Network, VM Network, etc). When using Virtualization Station, the network traffic from the virtual machines (VMs) is isolated from the network used by the Turbo NAS. The bandwidth for the Turbo NAS applications will not be impacted by the VM operations, and the VMs can have dedicated bandwidth for operating high-traffic applications. Also, you can flexibly install LAN cards and arrange other LAN ports for different VMs to use as a dedicated network resource.

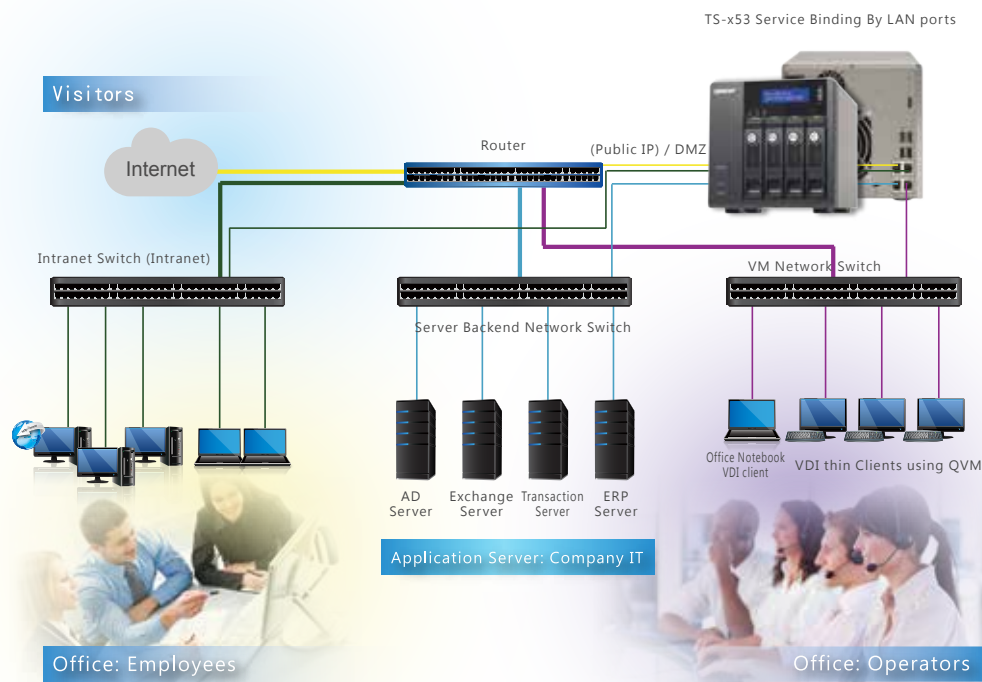

Port Trunking - Link Aggregation for high-speed and high-security file transmission

Including the practice mentioned above, 2 LAN ports can be used for Port Trunking - Link Aggregation, enabling IT administrators to set up link aggregation to increase total data transmission capabilities and achieve better efficiency for IT operations. Failover, load balancing, and multi-IP settings are also supported.

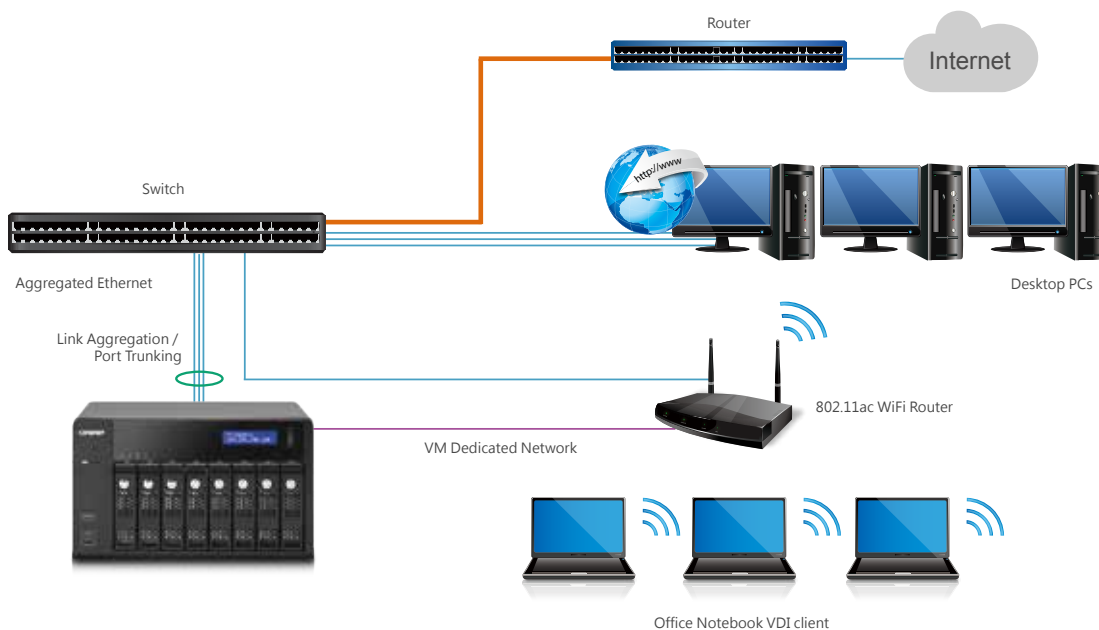

Wi-Fi network settings

TS-x53 Pro / SS-x53 Pro supports 802.11ac high-speed Wi-Fi networks. Connect a USB Wi-Fi network card to the NAS, click QTS [Control Panel] > [System Settings] > [Network] > [Wi-Fi], and the available Wi-Fi access points will be listed. The QTS 4.1 supports 802.11ac Wi-Fi network protocols. You can connect the TS-x53 Pro / SS-x53 Pro to a router supporting 802.11ac protocols for higher file transfer speeds.

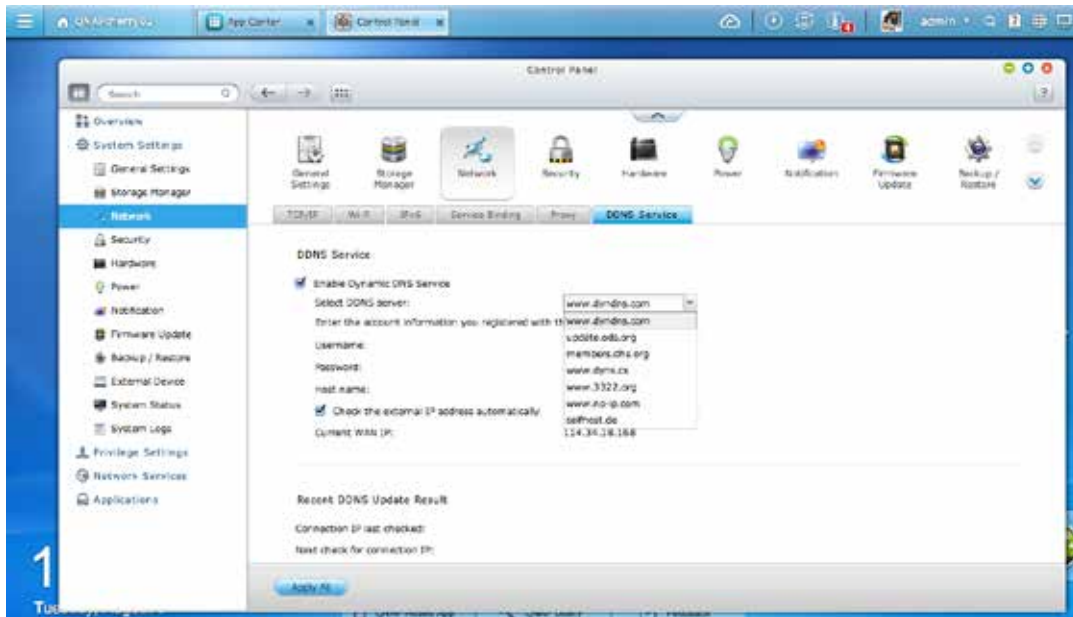

A Turbo NAS can support a USB Wi-Fi network card. Visit www.qnap.com for a full Wi-Fi network card compatibility list.

Dynamic DNS (DDNS) service

After connecting to the Internet, click [Control Panel] > [System Settings] > [Network] > [DDNS Service] to get the Internet IP address. The IP address can be a DHCP or a fixed address according to your Internet Service Provider (ISP). You can use the IP address and register a DDNS on a DDNS server. By properly setting up DDNS, the Turbo NAS ensures that it is always reachable by automatically updating its IP address with the DDNS service provider whenever the IP address changes.

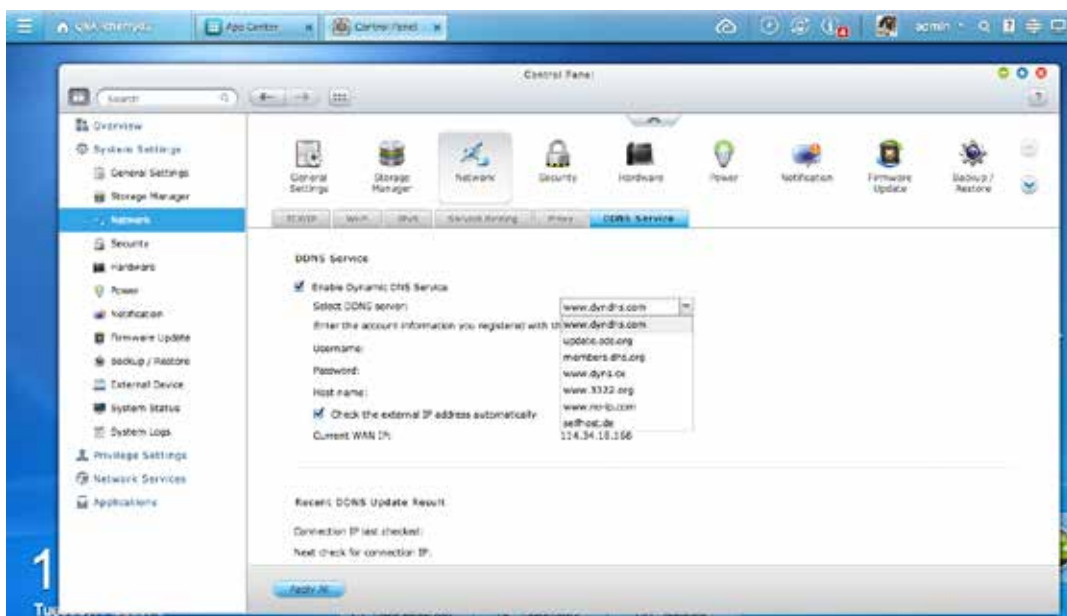

Uninterruptible Power Supply (UPS)

Activate the UPS support to ensure the Turbo NAS is properly shutdown if power fails. In the event of a power failure the Turbo NAS will shut down automatically or enter auto-protection mode by probing the power status of the connected UPS unit. You can set up the function by clicking QTS [Control Panel] > [System Settings] > [External Device] > [UPS].

■ Case study for NAS connecting to a USB UPS

You can set the Turbo NAS to shut down or enter auto-protection mode if the power fails, and determine the action after few minutes of the power failure. Once the auto-protection mode is activated, the Turbo NAS will revert to the state before power failure and continue to operate when the power restores.

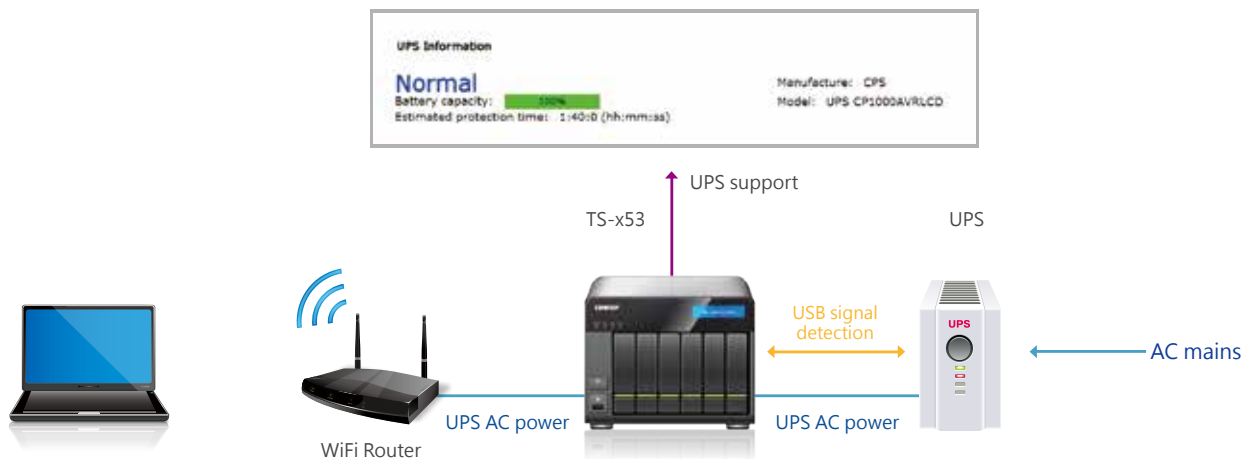

■ UPS with SNMP management

When the Turbo NAS and the SNMP-based UPS server connect to the same network, you can select [SNMP connection] and enter the IP address of SNMP UPS server to set up the power failure notification.

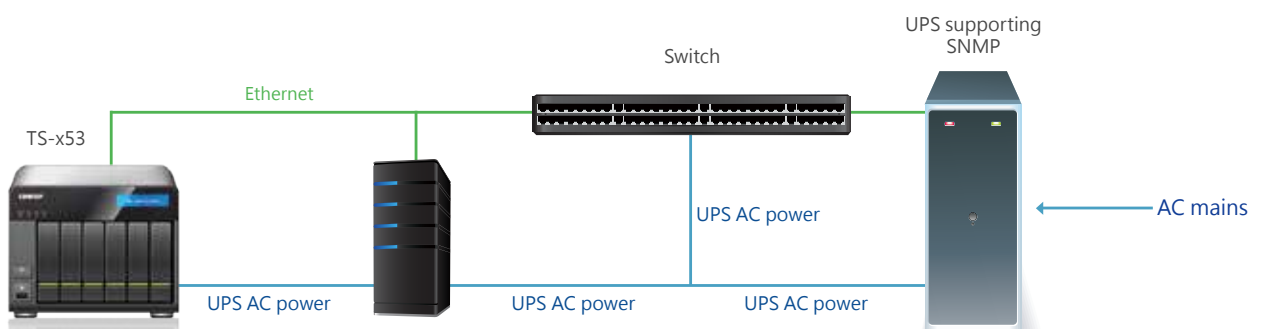

Multiple NAS units share USB UPS

The network UPS "master" is connected to the UPS via USB cable. If the power fails, the UPS sends a notification to the network UPS "master" via USB and all the UPS "slaves" are informed by the UPS master via Ethernet. To set your Turbo NAS as a UPS "slave": connect the UPS and the Turbo NAS by USB, select [NetworkUPS slave], enter the IP address of the master server, so the slave server will get notification when the power fails.

Step 1: Select "Network UPS slave"

Step 2: Enter the IP address of the master server

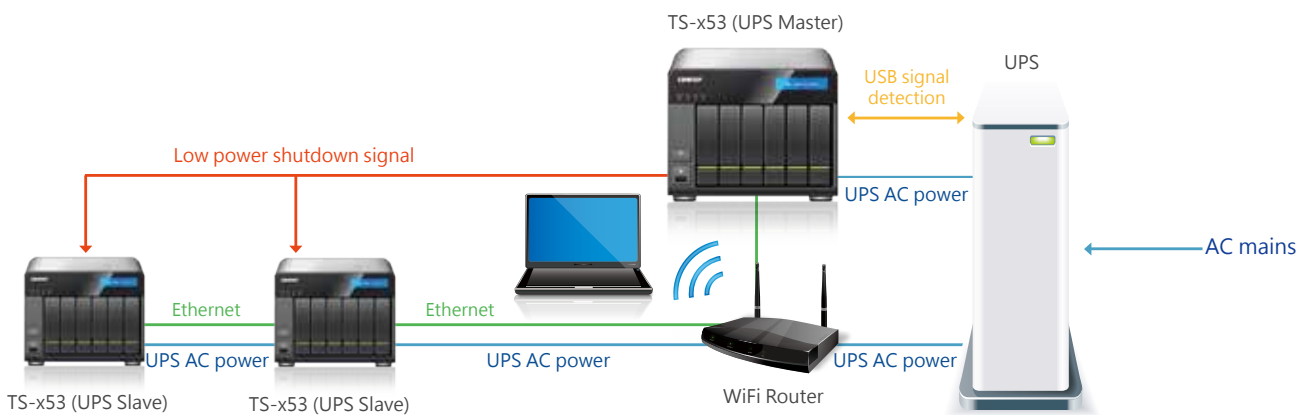
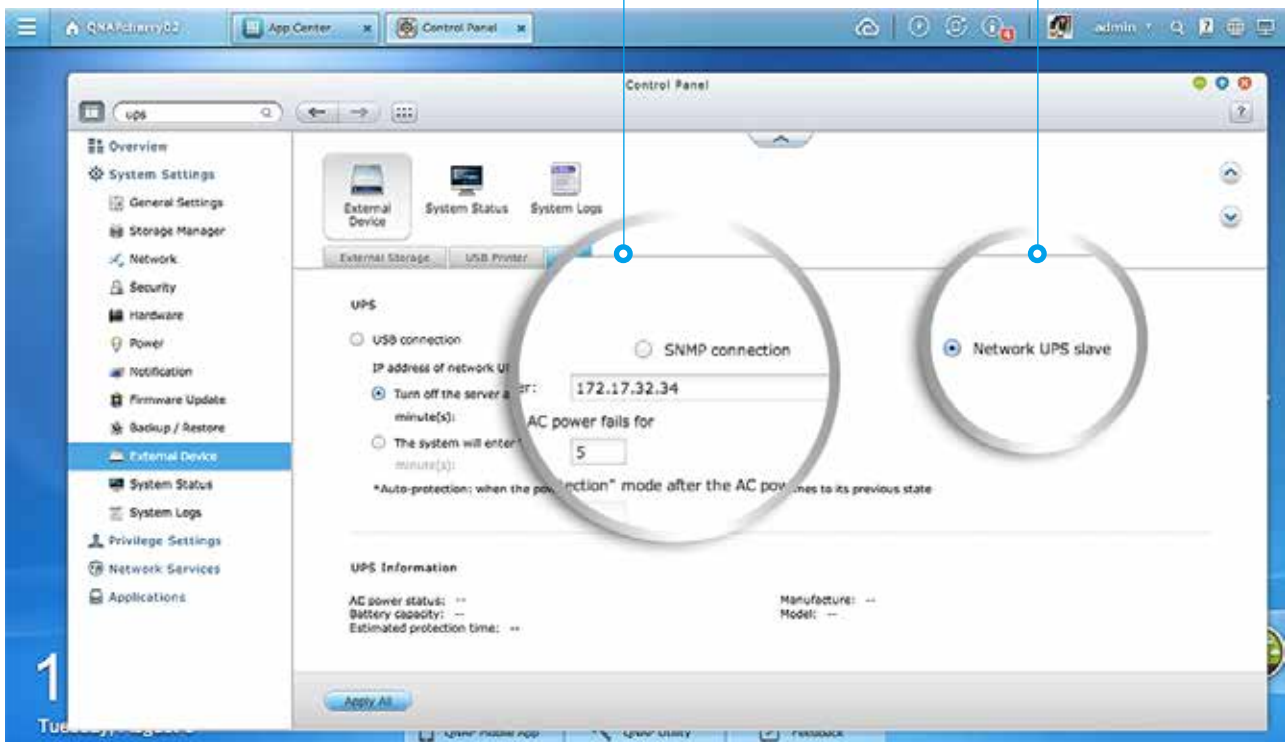

File Backup/Disaster Recovery

QTS allows data on PCs, servers, virtual machines, and external drives to be backed up to the Turbo NAS and provides disaster recovery solutions to back up data on the Turbo NAS to external devices and remote servers.

■ Backup Center

Backup from computer to NAS

PC backup

Windows users can install the free QNAP NetBak Replicator utility to back up files from Windows PC. Entire disk drives, documents, pictures, music, videos, fonts, emails, and more can be backed up to one or more Turbo NAS units.

With a few clicks, you can set up real-time backup, scheduled backup and auto-backup. You can set power off after the backup is finished to save energy, filter unwanted files, and receive email notifications when the backup finishes.

Mac backup

Mac users can use Time Machine to back up data to the Turbo NAS. You only need to set the Turbo NAS as the backup destination on the Time Machine management page and it's done.

3rd party backup software

QTS is compatible with various renowned backup software such as Acronis® True Image, Symantec® Backup Exec, and more. Users that use this software can immediately back up data from other sources to the Turbo NAS.



■ Disaster Recovery

Backup to remote server

- Use rsync protocol to execute scheduled backup to remote rsync server
- Use RTRR (Real-Time Remote Replication) services for real time data backup to a remote Turbo NAS or FTP server.

Backup to cloud storage

Users can back up the data from the Turbo NAS to online cloud storage services, such as Amazon® S3, Amazon Glacier, ElephantDrive®, Microsoft® Azure, Google® Drive, and Dropbox®, and restore the data to your Turbo NAS anytime.



Backup to external device

Connect your external device to a USB interface of the Turbo NAS, click [Control Panel] > [Applications] > [Backup Station] > [External Backup] to create a task to back up the Turbo NAS data to the external device.

QTS 4.1 OS



Security Management

QTS offers various security management options to protect the system from hacking and data from interception, theft, and loss. QTS security management meets the electronic requirements of HIPAA (Health Insurance Portability and Accountability Act), performing as an ideal storage solution to store medical records.

■ Privilege settings

Windows AD/ACL

QTS supports Windows AD/ACL to help IT administrators manage user account more effectively, and to simplify the process of privilege settings in large-scale organizations. QTS also supports SAMBA v4 that enables the Turbo NAS to serve as a Windows domain controller to manage privilege settings.

LDAP Directory Service

QTS supports the LDAP protocol, integrating the Turbo NAS into networks that have deployed an LDAP-based directory service such as OpenLDAP and greatly simplifying the efforts of managing a large amount of user accounts. QTS makes Turbo NAS a LDAP server too.

Radius Server

QTS RADIUS Server provides centralized authentication and authorization management for computers to connect and use a network service. The QTS RADIUS Server maintains a list of user accounts that are authorized for remote network access through dial-up equipment, Wi-Fi access point, or VPN connections. IT administrators can easily apply access policies to multiple access points for a fine-grained control of network access.

■ Anti-interception

VPN Server

QTS supports VPN Server, with VPN connections secured with up to 256-bit encryption. It is easy to configure and is seamless integrated with the QNAP myQNAPcloud service and Auto Router Configuration. Complicated port forwarding settings for PPTP and OpenVPN are therefore simplified.



VPN Client*

QTS supports VPN Client with the support for PPTP/OpenVPN, allowing Turbo NAS outside the company's Intranet and connect to the VPN Server in the company. It increases the security of data transmission when transferring files between Turbo NAS units.

*Available in QTS 4.1.2

Encrypted access

QTS supports SSL, SSH and SFTP for secure connection and data transfer. IT administrators can host websites on the Turbo NAS and only allow access via HTTPS (SSL over HTTP) secure channel.



The support for "VPN Client" will be available soon. A Turbo NAS cannot be a VPN Server and VPN Client at the same time.

■ Anti-hacking

IP blocking

IT administrators can set up the black and white lists to grant proper access from different users to the Turbo NAS by IP address. It operates as a policy-based automatic IP blocking by enabling the network access protection command.

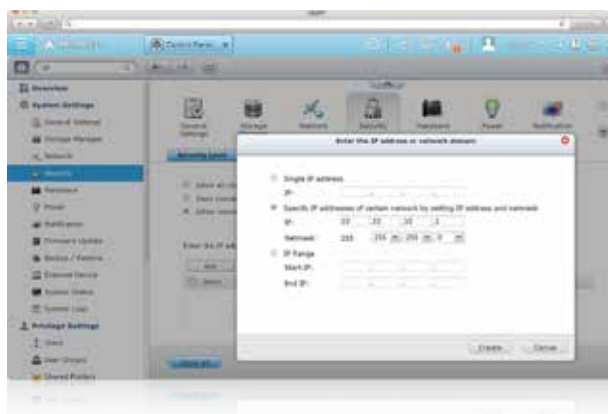

■ Anti-theft

Hard drive encryption

QTS supports up to AES 256-bit encryption for internal drives and external USB/eSATA drives, and adopts a military-level FIPS 140-2 validated encryption, which is considered to be the highest security certification for compliance.



■ Anti-virus

Virus scan

QTS integrates the ClamAV antivirus toolkit to defend against the latest viruses, malware, worms, and Trojan horses with continuous free virus database updates, ensuring continuous business operation. An email notification upon task completion or virus detection is provided. QTS also supports McAfee virus scanner which is available in the QTS App Center with a free 30-day trial.

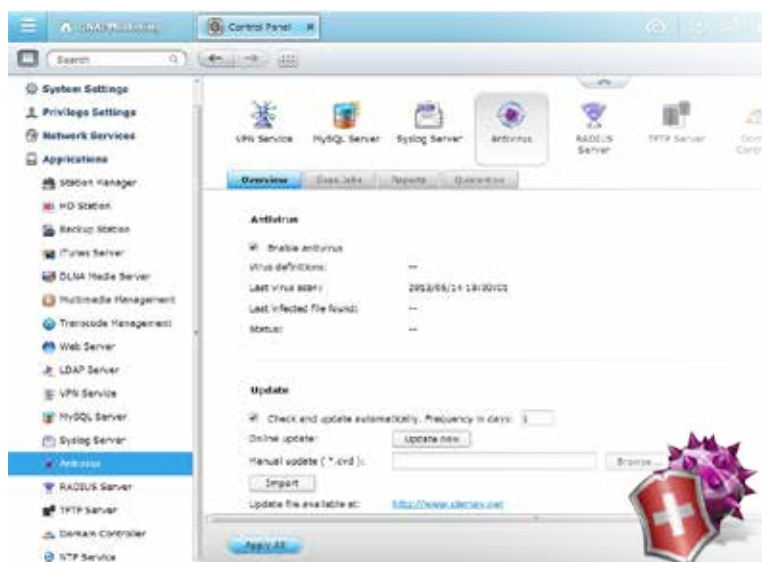

QTS 4.1 OS

myQNAPcloud SmartLink



■ myQNAPcloud connection

With the myQNAPcloud service it's easy to create a personal/private cloud for enjoying your Turbo NAS services safely and conveniently.



myQNAPcloud ID (QID)

Access your Turbo NAS by signing into your myQNAPcloud portal (www.myqnapcloud.com) with your "QID" : a unique ID for you to access your Turbo NAS and securely share your private data and files.

Publish and share

myQNAPcloud is an easy-to-setup service that simplifies the steps in publishing Turbo NAS content over the Internet. On QTS myQNAPcloud, you can select numerous web-based Turbo NAS services, such as Photo Station, Music Station, and File Station to be published to the myQNAPcloud.com website. Likewise, you can easily view friends' public services on the myQNAPcloud.com website too.

Web-based file management

The myQNAPcloud portal enables you to manage multiple Turbo NAS units in one place. With the easy-to-use management interface, you can simply download, move, and copy files on your Turbo NAS, lessening the difficulty in accessing multiple Turbo NAS servers. All you need is to sign into myQNAPcloud.

Trustworthy file protection

To ensure the security of remote access service, myQNAPcloud strengthens keys on SSL Certificates to 2048-bits. The files on the Turbo NAS are 100% under the NAS owner's control.



myQNAPcloud Connect

myQNAPcloud Connect application is designed for Windows PC users. By installing the myQNAPcloud Connect, users are able to connect to the Turbo NAS and easily manage files by dragging-and-dropping within Windows Explorer.





CloudLink for easy remote access

myQNAPcloud features the new CloudLink App (QPKG) for an easier remote access experience. Without any complex router settings, all you need to do is install the app and login with your myQNAPcloud ID (QID), then you can access to your Turbo NAS through the myQNAPcloud.com website. CloudLink will automatically choose the best way to connect based on your network environment. CloudLink supports access to the Turbo NAS via mobile devices with the Qfile/Qmanager apps or via computer with the Qsync utility.

Visit the QNAP App Center to download the CloudLink App (QPKG), and experience the new myQNAPcloud Smart Link remote access service.

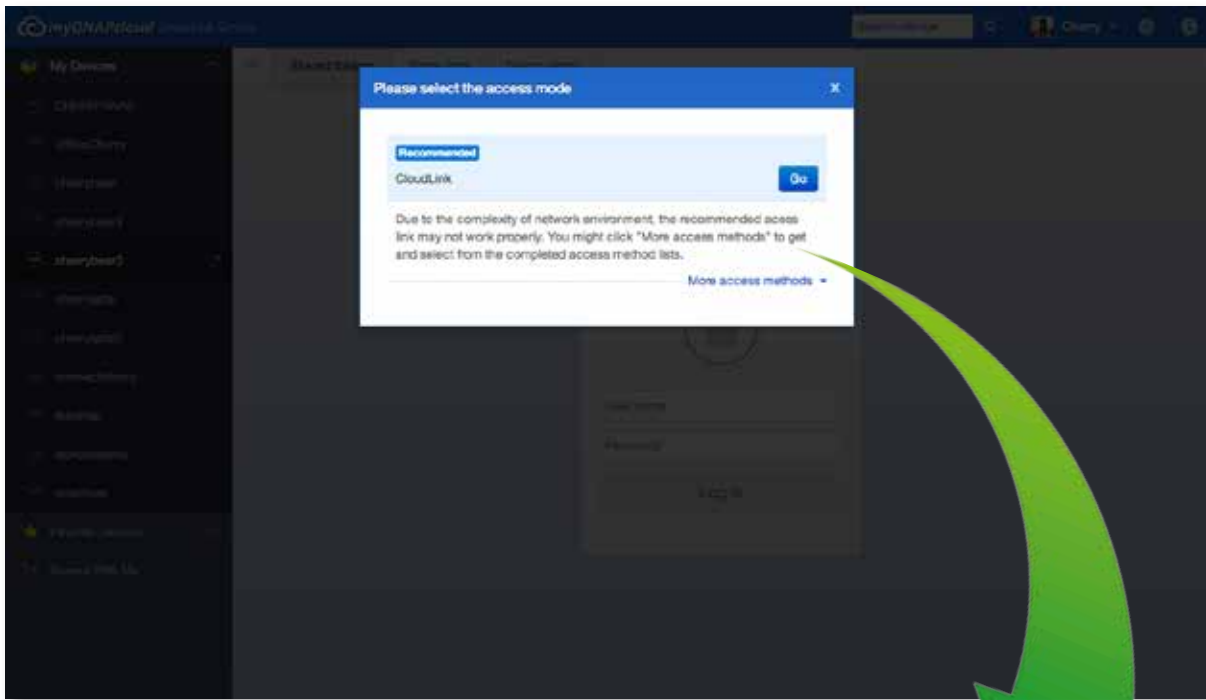

Automatically choose the connection method



Please note: the CloudLink App (QPKG) requires firmware v. 4.1.0 or newer.

QTS 4.1 OS

File Management



■ File Station

With File Station, you can easily manage, upload, download, share files, and enjoy media playback anywhere with a web browser. File Station brings conventional file operations performed on the computer desktop to the web browser.



File upload

Easily upload the files to your Turbo NAS by dragging-and-dropping them into File Station.

Mutual file sharing

You can easily share multiple files in a shared folder with friends via a Share Link. By activating the file upload function, your friends will be granted the privilege to upload files to your File Station without requiring a user account. You can even set an expiration time for shared files.

Photo slideshow

Right-click on selected photos to play a smooth slideshow.

Media streaming & playing

File Station supports VLC for multimedia streaming. Just click on your photos, music and videos to directly play them. The slideshow display helps gather media files in an organized manner for you to preview and play.

Click and play videos

TS-x53 Pro / SS-x53 Pro supports real-time transcoding which allows immediate and smooth video, music, and photo playback. No need to wait for the files to be converted in advance.



Real-time transcoding allows maximum 5 users to simultaneously connect and watch videos. Offline transcoding allows more users. Check page 11 to learn more about transcoding feature.



Advanced quick search

File Station provides smart filters for file searching and browsing by file size, modified date, file name, and so on. Pop-up thumbnails enable you to quickly & clearly preview files. File browsing is more intuitive with File Station.



Photo thumbnails preview

File Station makes file management easier by showing thumbnails of photos, music and videos.



Recycle bin

The recycle bin helps retrieve files accidentally deleted. It is categorized by shared folders to increase file retrieval efficiency.

Compress/Extract multiple files

If you need extra space you can easily compress files & folders into a Zip file. You can also easily unzip files straight to File Station.



QTS 4.1 OS



■ Qfile: Share files with mobile devices

You can install the Qfile app on your mobile device to browse and manage files stored on your Turbo NAS anytime, anywhere.

Access from anywhere

Open Qfile on your mobile device to browse files on the Turbo NAS. You can open or share files, and easily rename, copy, move, download any selected files.

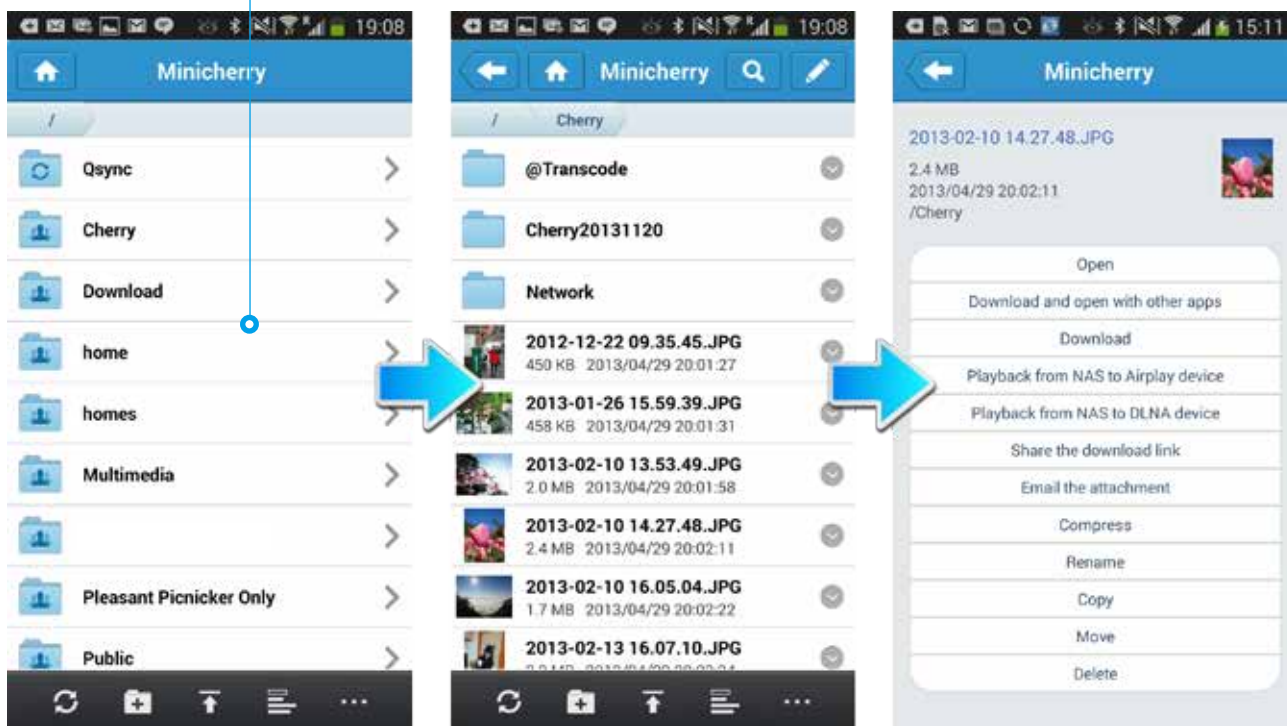

Qfile will download the file to your handheld device and send it via your default email function. This file cannot exceed 20MB, so please ensure there is enough free space on your device to save the file.



Install Qfile on your mobile device to browse and manage files stored on your Turbo NAS anytime, anywhere.

Available on the
App Store



Google play





Stream multimedia contents

Use Qfile to stream multimedia content to AirPlay or DLNA-compatible devices and play to enjoy.

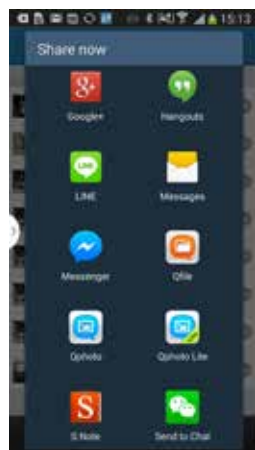
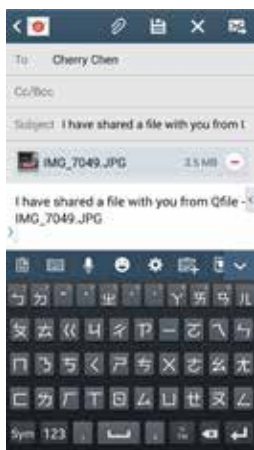

Share files instantly

Qfile provides various ways for instant file sharing, including email or SMS.

Qfile also provides Share Links to easily share large files. You can paste the Share Link on instant messenger such as LINE, WhatsApp, WeChat, and more to share files with others.

Your friends can click on the Share Link to download the files.

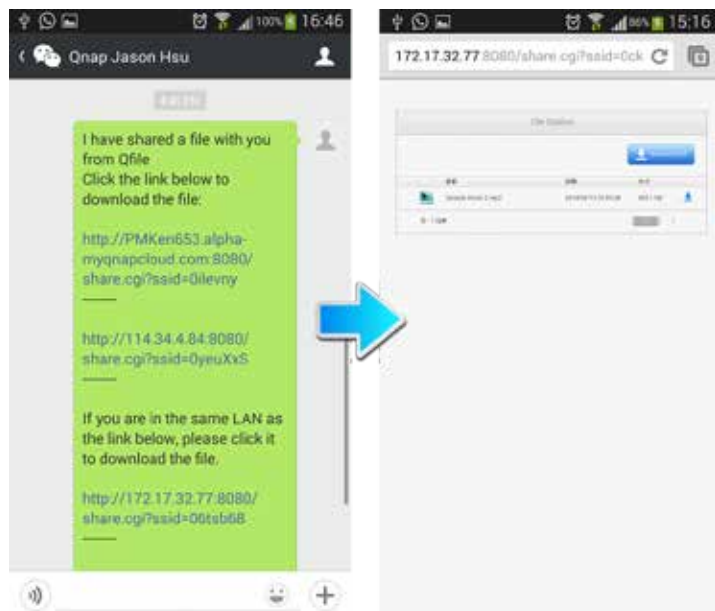

QTS 4.1 OS



Qsync: A Powerful Utility for File Synchronization in Business & Personal Applications.

Public cloud files synchronization services such as Dropbox can greatly increase the efficiency and productivity of offices, but comes with certain drawbacks:

1. Security: there is the possibility of data leaks and interception of confidential information.
2. Cost: the greater the size of your data storage needs, the greater the cost of the service.

With QNAP's Qsync utility on Turbo NAS, IT administrators can create a Dropbox-like private cloud with a larger storage capacity to fulfill business needs. Any files added to the Qsync folder will be automatically accessible across multiple devices, and synchronized with different work groups flexibly and effortlessly. With no additional costs or storage limits, Qsync can centralize files from different work groups and assist in teamwork on important projects anytime, anywhere.



7 reasons why you need Qsync

1. Cross-device synchronization

Qsync turns your Turbo NAS into a safe data center for files synchronization. Every file uploaded to the Qsync folder will be made available to multiple devices including computers, laptops and mobile devices. When you are away on a business trip, Qsync ensures that the most up-to-date files are accessible on all linked devices and reduces your need to rely on USB storage to carry files and on emails to get the latest files.



Synchronize with Windows

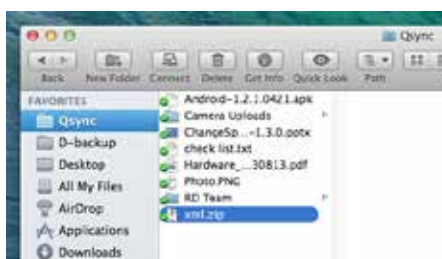

Synchronize with Mac



Synchronize with iPhone/Android smartphones via Qfile. Synchronize with iPad via Qfile HD

2. Intelligent offline editing

You can edit your files offline and once your device is online, Qsync will automatically sync them. This offline editing feature ensures your files are protected without any information loss.

3. Flexible synchronization methods

Qsync has many sync settings to prevent taking up significant storage space on your computer. With both Full Sync and Smart Sync options, you can choose to synchronize all the files in the Qsync folder or you can enable the Smart Sync option to remove local files without affecting the centralized files stored on your Turbo NAS.

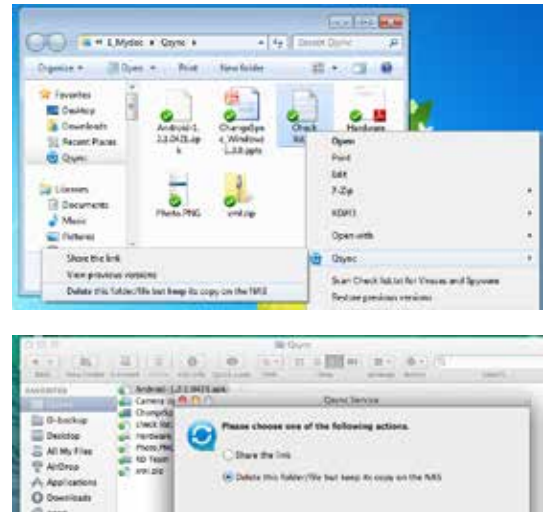

4. Share files & folders more efficiently

You can create sub-folders within the Qsync folder, share each with different work groups and everyone with the same sub-folder is always kept up-to-date with the latest files. All your files are shared via drag-and-drop. With Qsync, your Turbo NAS becomes an aggregative data center and greatly enhances teamwork flexibility.

5. Auto-upload from mobile devices

You can enable the auto-upload option on the Qfile mobile app and automatically sync your files to multiple devices. Your meeting minutes, notes, and seminar recaps will be automatically uploaded and synchronized as well.

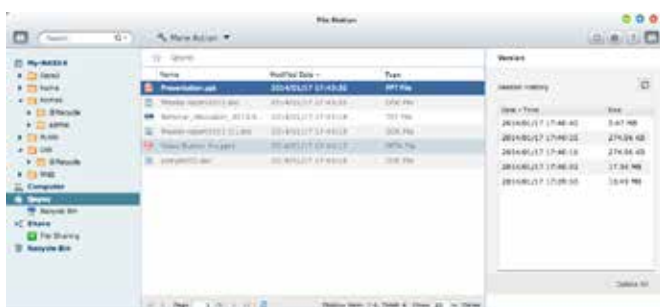

6. Integrated version controls protect against accidental deletion

The Turbo NAS will retain up to 64 versions of files when they are modified, allowing you to retrieve a specific previous version at any time. Even if you have accidentally deleted the file you can restore previous versions from the recycle bin. With capacity-efficient restoration, the reserved version only keeps the changes made to the file and assists in optimizing your storage space.

7. High security

Qsync can create a private cloud within your intranet and benefit from your existing secure network environment. The Turbo NAS also supports HTTPS connection assisting in creating a safer, more reliable business network environment.

Unified Storage and Virtualization Applications

The Turbo NAS supports iSCSI & NFS protocols and is virtualization ready with compatibility for VMware®, Citrix®, and Microsoft® Hyper-V to provide businesses with powerful & flexible storage solutions for virtualization applications.



■ Virtualization ready

The Turbo NAS supports VMware® vSphere 5 and VAAI; Citrix® XenServer 6.0, and is compatible with Microsoft® Hyper-V, supporting ODX and Windows Server 2012.

■ VAAI/Hyper-V Plug-in Support

Use the free QNAP vSphere Client plug-in and QNAP SMI-S provider for SCVMM and managing the Turbo NAS from the virtualization management client console is easy.

■ Secure and flexible storage utilization

The Turbo NAS offers flexible management through creating and allocating iSCSI LUNs (Logical Unit Numbers), mapping and unmapping LUNs to and from iSCSI targets, and thin provisioning. CHAP authentication and LUN masking support reinforces secured deployment in virtualization applications.

■ NAS/IP SAN unified storage

QTS supports NFS and iSCSI/IP-SAN storage solutions that can be utilized as network-shared storage of virtualized environments, helping to achieve an efficient cost-saving, energy-saving optimized storage capacity.

■ VAAI for iSCSI, VAAI for NAS

The QNAP NAS, VAAI iSCSI and VAAI NAS are VMware certified. Businesses can select either iSCSI or NFS as a centralized storage to boost performance. VAAI for iSCSI supports Full Copy (hardware-assisted copy), Block Zeroing (hardware-assisted zeroing), Hardware-assisted Locking, and Thin Provisioning with space reclaim. VAAI for NAS supports Full File Clone, Extended Statistics, and Reserve Space. The QNAP NAS supports VAAI iSCSI and VAAI NAS to enhance storage performance in a virtualized environment.

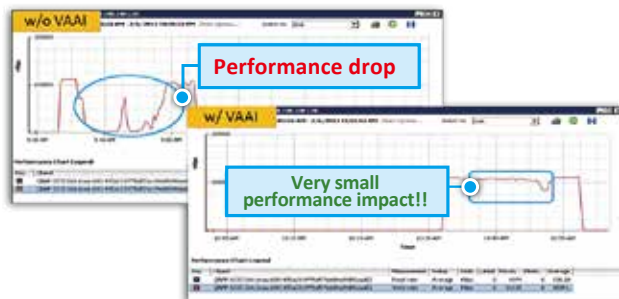
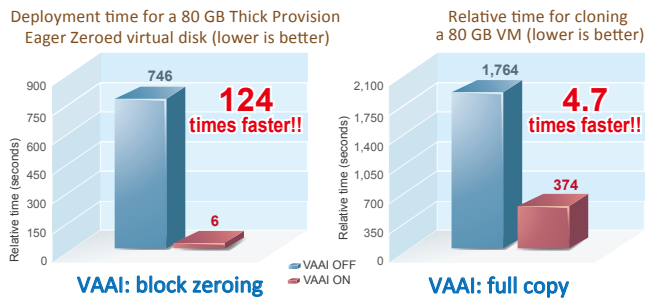

VAAI: Hardware-assisted Locking

QNAP Turbo NAS: Boosted Performance by ODX

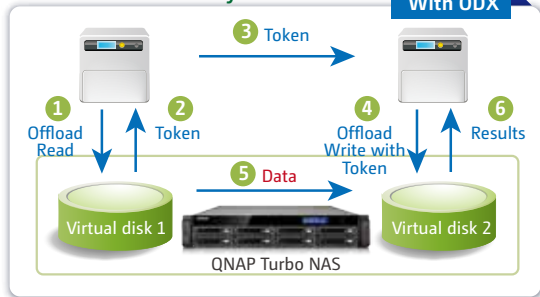

Other NAS

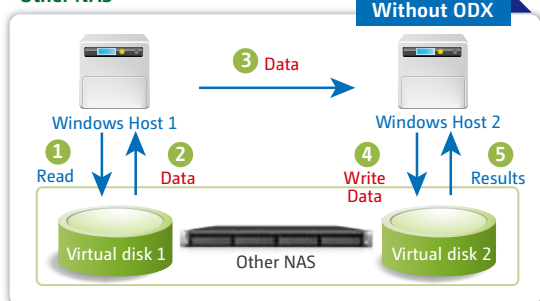

■ Storage for Microsoft Hyper-V

With ODX support, the QNAP Turbo NAS becomes a high-performance iSCSI solution under Windows Server 2012, including Hyper-V virtualized environments. QNAP storage enables full copies of virtual machines within the NAS without requiring the Windows hosts to read and write the data to highly reduce the load on Windows hosts and improving the performance of copy & move operations on Windows 2012 hosts. When providing QNAP storage to a Windows 2012 file server, the end user using a Windows 8 client workstation will also benefit from the Offloaded copy process for large file transfers.

■ vSphere plug-in

The vSphere plug-in allows users to manage the QNAP Turbo NAS directly on the vSphere client, making datastore management more effective.

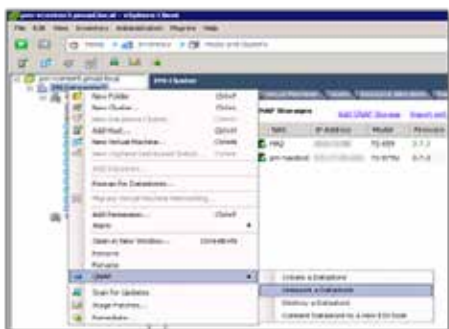

■ NAS management via SCVMM

QNAP SMI-S enables management of the QNAP Turbo NAS directly through Microsoft System Center Virtual Machine Manager 2012 (SCVMM)



QTS 4.1 OS



■ IT Management Station

Powered by Mandriva® Pulse, IT Management Station is designed to simplify daily tasks and IT asset management for businesses of all sizes. Your Turbo NAS becomes an IT system management server to help you centrally manage multi-OS & multi-site IT resources, applications and security with greater flexibility.

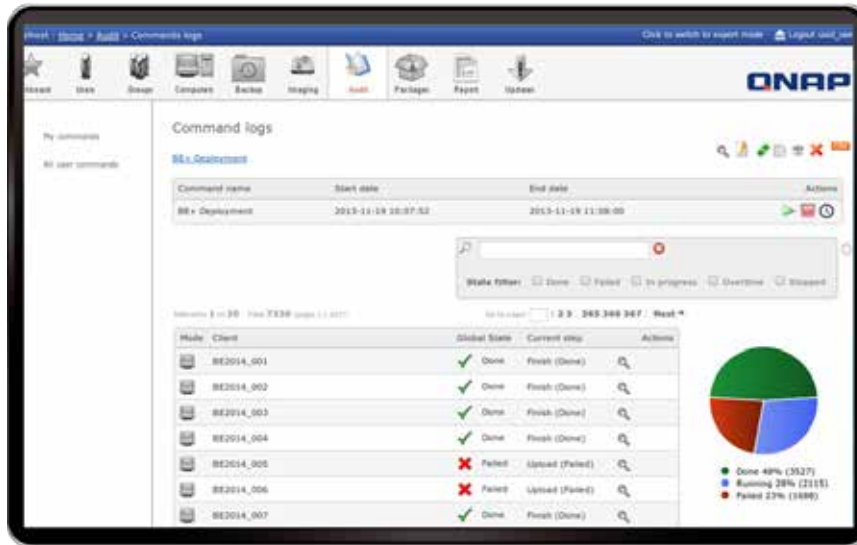

■ At the core of Pulse



Comprehensive Inventory
Pulse automatically retrieves hardware & software information from your IT system using an inventory agent to provide you with reliable and timely data. It measures the potential of your inventory and runs your IT assets tactfully, thanks to dynamic groups, self populated from queries.



Cloning
As part of a scheduled or on-demand restoration, systems and their stored data can be fully backed up easily.



Deployment
Design, schedule and implement software installation on your IT assets.



Mastering
Create generic disc images to carry out mass OS deployments.



Backup and Restore
Save time, optimize storage and protect data from accidental loss using incremental backups.



Remote Control
Help your users in their everyday tasks by connecting from remote locations without compromising the security of their IT assets.

■ New features in Mandriva Pulse 2.0

Reporting

Create and edit reports/graphs for better control of your IT assets and to anticipate future changes.

Pull Mode

Increase the compliance of your roaming devices for deploying packages needed in any environment.

License Management

Optimize your software assets with an overview of used and available licenses.

Update Management

Centralize your software updates for greater control and security.

Software Convergence

Efficiently deploy software using an automated process.



■ Flexible management of your IT assets

Multi-OS

Manage all your IT assets and virtual machines no matter if it is Windows, GNU/Linux, Mac or Unix.

Multi-site

Remotely & securely manage your sites via SSH tunnel, simultaneously controlling the bandwidth and conserving the availability of your network.

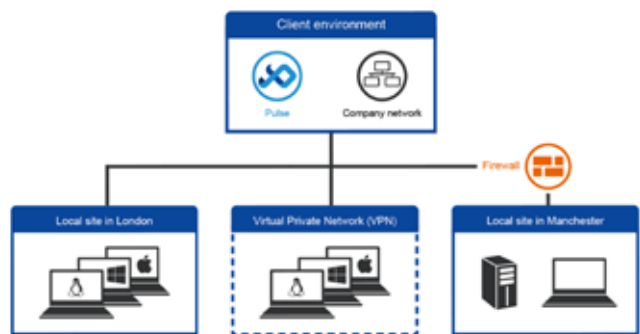

■ Intuitive tools

Features a desktop icon for quick self installation to facilitate access and remote control of new deployments.



A simple web interface with an intuitive dashboard for quick information regarding your IT assets.



A unique management interface for software licenses and automatic package management.

QTS 4.1 OS



■ Signage Station

The Signage Station is a free Turbo NAS app that allows businesses to create attractive menu boards, advertising posters, and business profiles and easily publish them to monitors and tablet devices to attract more customers.



Drive business growth and increase revenue

Your content can be presented on a web browser and when on the go, and you can even show your profile, business card and product catalogs on mobile devices and share on Facebook. The Turbo NAS with the Signage Station is an ideal tool to present creativity and drive business growth.

Instantly publish and conveniently revise

With iArtist Lite you can save your designs as different projects and upload them to multiple Turbo NAS with Signage Station installed. Whenever you want to revise the content, just open iArtist Lite to update and publish instantly. You can fully control all your content in a timely way.

Absolutely easy-to-use

iArtist Lite provides a drag-and-drop interface that allows you to flexibly embed videos, marquees, pictures, and PowerPoint slides on the canvas panel. With the layered playlist and timeline features, you can freely arrange the order of media objects. iArtist Lite also offers numerous templates for various scenarios, saving you lots of time & effort. Useful widgets such as audio, clock, RSS are also available to add to the designed content.

Collaboration increasing efficiency

The original content can be saved on a local computer or the Turbo NAS with the help of the connection wizard. Content saved on the Turbo NAS is accessible for every authorized user to increase the work efficiency in projects involving multiple members.



■ Create your advertising content easily

How to make advertising content on iArtist Lite?

The concept of dynamic multimedia content is quite simple: just drag & drop media files to the iArtist Lite canvas and arrange it as required.

Choose the device that you want to display, such as tablet, HDTV or smartphone. After selecting the device resolution you can select whether to present it in portrait or landscape.



Introduction of iArtist Lite functions :

- | | |
|--------------------------------|----------------------------------|
| A Add new content | D Upload to Turbo NAS |
| B Open previous content | E Preview design |
| C Save content | F Online template support |

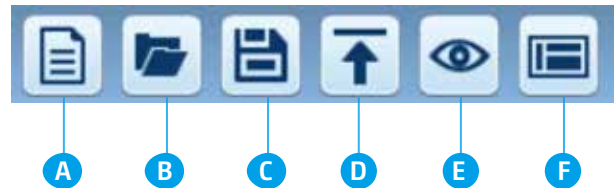

Introduction of iArtist Lite tools :

- Video, photo, and music: Add the file to the canvas from Windows.
- Digital & analog clock: Supports multiple types of clocks and formats, just drag & drop to canvas.
- Background image: Choose a background color or choose a background image.
- Mask: Add an image mask to the content.
- Text & banner: Edit the text on the banner you would like to promote.
- RSS: Share an RSS link from a website to share messages.
- Digital menu board: Design a neat menu board, and edit the price and picture anytime, anywhere.
- Combo menu board: Select the template and add the price and picture.
- HTML: Drop a website on the canvas for the most direct promotion.
- PPT and PDF: Easily add documents to the canvas including slideshows, retaining the animations from the PPT.



Intuitive user interface with timeline view

After dragging & dropping from the left panel to the canvas, each media file will have a corresponding timeline at the bottom of the canvas to allow users to easily manage their timing and placement.

QTS 4.1 OS



Surveillance Station

One of the standard Turbo NAS applications, the Surveillance Station is professional network surveillance Video Management System (VMS) that can be activated in the QTS App Center to turn the Turbo NAS into a professional Network Video Recorder (NVR) system for real-time monitoring, recording, playback, alarm notifications, Intelligent Video Analytics (IVA), and management to safeguard your assets and property when used with supported IP cameras. The TS-x53 Pro/SS-x53 Pro series comes with **2** free camera channels, allowing users to easily build a surveillance system.



2 free camera license

Highly-professional NVR system

Wide range of supported IP cameras

Surveillance Station is compatible with over 2,600 IP camera models across over 90 brands and ONVIF specifications, including those that support advanced features such as multi-streaming and fisheye dewarping.

Comprehensive Turbo NAS support

TS-x53 Pro/SS-x53 Pro offers 2 free IP camera channels and can be expanded to 24 channels to fulfill various surveillance deployment needs.

Cross-platform support

Surveillance Station works with all major web browsers including Google Chrome, Mozilla Firefox and Internet Explorer. With the QNAP Surveillance Client for Mac, users can enjoy a similar experience on their Macs.

Advanced storage technology protection

Surveillance Station is installed on the Turbo NAS platform and is protected against loss, theft, and damage of recorded videos with the help of advanced security features and RAID technology.



Please note: You can also use USB webcams for Surveillance Station to record videos. Just install the QUSBCam App on a TS-x53 Pro/SS-x53 Pro from the QTS App Center to assist in building a small surveillance system for your office with USB webcams.

Live-view

Various remote monitoring modes

The Surveillance Station supports various monitoring modes to display up to 64 channels on a single screen. Users can also choose to sequentially display each channel or use dual displays for more information.

PTZ (Pan/Tilt/Zoom) control

On the Surveillance Station web interface, you can directly adjust the PTZ (Pan/Tilt/Zoom) functions of supported cameras, greatly enhancing the convenience in remote monitoring.

Instant playback

On the Live-view page, whenever you want to check suspicious events of a camera channel you just missed, just hit `Instant Playback` to bring up the window to review recent events.

Visual aid by E-map

Just upload pictures of monitored locations to the Surveillance Station and drag & drop the IP camera icons to them on the E-map. Once an alarm event happens, the camera icons will flash to indicate the event type for you to be immediately alerted to take necessary actions.

Instant notification

When alarm recording is enabled and an event occurs, an alarm icon will be instantly shown on the monitoring page. The alert details can be viewed by clicking the icon.



Playback

Preview recordings by thumbnails

You can move the mouse cursor over the timeline to preview video thumbnails to quickly identify and search for events. No need to play the video from the start and wait.

Intelligent Video Analytics (IVA)

IVA is an advanced way to quickly search videos corresponding to particular modes, greatly saving the time & effort of manually screening out matching videos. IVA includes motion detection, foreign/missing objects, out-of-focus and camera occlusion.

Real-time watermarking

The support of digital watermarking assists in verifying the authenticity of exported videos and snapshots by showing the exact recording date & time, camera name, and Turbo NAS model name, making it essential when videos are needed as verifiable evidence.

Playback and speed control by shuttle bar

With the speed control shuttle bar, you are able to fast forward playback by dragging the button to the right and to the left to rewind, helping you quickly find the desired screenshots.



Flexible Management

Flexible camera access control

You can create up to 32 user accounts on the Surveillance Station and flexibly assign them to different user groups with different rights for monitoring, playback, PTZ control, and audio monitoring.

Advanced event management

The system starts alarm recording when alarm events occur. Administrators can configure events and assign 7 types of event actions to ensure that they are alerted immediately, including recording, PTZ Control, alarm output, email notification, SMS notification, buzzer notification, and user-defined actions.

Expendable license management

The Surveillance Station comes with at least one free IP camera license for each Turbo NAS by default. Administrators can expand the channel number by purchasing additional licenses based on their demands. This provides a flexible and cost-effective method for scaling surveillance needs.

Manage large-scale camera

By connecting multiple Turbo NAS units, you can simultaneously manage, monitor and playback up to 128 IP cameras with one Turbo NAS. effective method for scaling surveillance needs.

Mobile apps

VMobile – Surveillance at anytime, anywhere

VMobile allows you to monitor the Surveillance Station anytime, anywhere using iOS and Android devices. It provides camera live-view, PTZ control, instant event notifications, video snapshot, video playback, and searching videos by date and time.

Vcam – Turn your mobile device into a camera

Vcam turns your mobile device into a network camera. With the Vcam mobile app, you can record any moment around you to your Turbo NAS, saving the need in buying expensive IP cameras.



App Center & Developers



App Center

The QTS App Center provides various apps for you to install on demand, enjoying more applications and increasing the value of your purchase.

Powerful and, Rich-in-content

The App Center provides over 100 apps, including backup/sync, business, content management, communications, developer tools, download, entertainment, surveillance and utilities.

Install on Demand

Find what you need and install it immediately with just one click.

Upgrade Reminder

If newer versions of your installed apps are available, an upgrade reminder will show on the QTS desktop to help you keep your Turbo NAS applications up-to-date.



★ Most Popular Apps :



Dropbox App

The Dropbox service is a cloud-based storage service that allows you to access your photos, documents, and videos anywhere, anytime with easy sharing. The free space from the Dropbox service is limited however, and to make it more efficient you can connect it with your Turbo NAS to store files.



How to use the Dropbox App?

The QNAP Dropbox app can synchronize your Dropbox account and your Dropbox folder on the Turbo NAS in both directions and in real-time. After you install the Dropbox QPKG and log into your Dropbox account, a Turbo NAS folder called "Dropbox" will be created and the synchronization process will start. With Real Time Remote Replication (RTRR), a built-in Turbo NAS function, you can easily back up files from your Dropbox account.



Google Drive Sync App

Google Drive is a cloud storage service provided by Google that lets users save their files online for accessing them anywhere. By installing the Google Drive Sync QPKG on your Turbo NAS you can select a shared folder to synchronize data with Google Drive or simply use Google Drive as a backup destination.



The following multimedia applications are disabled by default on TS-x53 Pro/SS-x53 Pro to conserve system resources. To enable them, go to “Control Panel” > “General Settings” > “System Administration” .



■ Video Station

Build a corporate video website

Video Station is great for archiving and playing video collections online. Just upload videos, and the Video Station will smoothly play the video with an optimized resolution for your device and bandwidth

Easy video sorting

You can easily categorize your videos as company videos, movies, TV shows, and music videos for greater organization.

Smart collection

Create a smart video collection that matches predefined criteria for names and ratings, making it easier to find the videos you want to watch.

Easy video sharing

Share your videos with friends & family via email, download link or social networking sites including Facebook, Google+ and Twitter.



■ Music Station

Organize huge music collections

Browse your music in multiple ways, create up to 200 playlists, and rate your music to feature it in a "My Favorites" collection.

Cloud music center

Access the Music Station via the Internet to enjoy your entire music collection from anywhere on any device.

Listen to thousands of Internet radio stations

With the built-in Tuneln radio, you can listen to thousands of local and global online radio programs. You can also manually add new radio stations.

Direct audio output

Turn your Turbo NAS into a complete music system by connecting USB speakers for direct audio output.



The free Qmusic mobile app allows you to listen to your complete music collection anytime and anywhere. Scan the QR Code to download!

App Center & Developers



Photo Station



Centralized management

All of your photos, including RAW photos, can be centrally managed with the Photo Station.

Convenient virtual albums

Easily create virtual albums for convenient sharing and better organization with no extra storage space needed.

Review photos on Google Maps

Retrace the steps of your photos by geo-tagging them and creating a map of your photo albums in Google Maps.

Private collection

Create a protected private collection of personal photos & videos that can only be accessed by you.

Play by slideshows

Create attractive slideshows using photos and music stored on your Turbo NAS.

Group photo sharing

Share photos in groups by saving them in Team Folders in your Qsync folder, allowing people with access rights to the Team Folders to browse those photos in their Photo Station.



Download Station

Your 24/7 download center

Once you finish managing download tasks, just turn off your computer and they will keep downloading until they are finished.

Powerful BT search engine

Easily find and add files to your download list with the built-in search engine.

Wide range of supported downloads

Supports downloading from BT, PT, Magnet, FTP/FTPS, HTTP/HTTPS and RSS.





▪ AirPlay support

AirPlay

Use the Qfile app on iOS devices to browse media stored on your Turbo NAS for playing on AirPlay-enabled devices (including Apple TV.)

QAirplay

The QAirplay app allows you to stream media content directly via Apple TV, bypassing and saving the energy of your mobile device.



▪ DLNA

Media streaming and playing

Stream your videos from your Turbo NAS to DNLA devices such as Smart TVs, video game consoles and media players.

Third-party Development Platform

With its open-source Linux kernel, QTS is a friendly development platform that allows software developers to create all kinds of applications. Developers can also enjoy a more efficient R&D process with the backup, security, cloud storage tools, and reliable Turbo NAS hardware design.

Dedicated customer service, sales and R&D support

QNAP Turbo NAS applications can be developed using the following three approaches :

Development Toolkit (API & SDK) :

Developers can use the QNAP Development Toolkit (API & SDK) to design applications that run on client devices (such as smartphones and PCs) to remotely manage and access files stored on their Turbo NAS.

NAS App (QPKG) Development :

Developers can design add-ons/apps for the Turbo NAS and have them seamlessly integrate with data stored on the same platform. Developers can also distribute their apps via the QTS App Center.

VM Integration :

Depending on your OS needs, you can use VM integration to install an alternative OS to run non-Linux-based applications on the Turbo NAS.

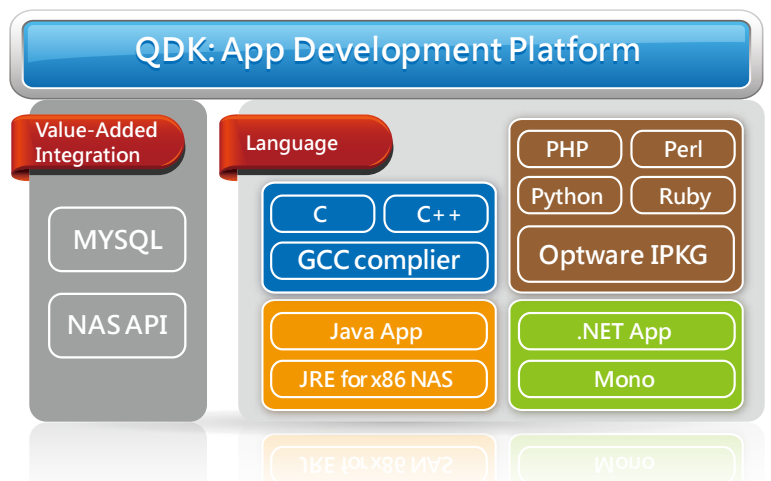



Microsoft Azure

Azure provides on-demand infrastructure that scales and adapts to your changing business needs. Whether you are creating new applications or running existing applications we provide the best price-performance and end-to-end support.

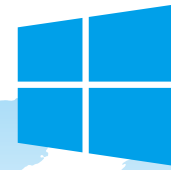

Microsoft Azure

Features

- Never wait for servers or infrastructure again
Instantly provision Windows and Linux Virtual Machines, apps, and infrastructure within Microsoft-managed data centers around the world.
- Develop amazing apps
Develop great Azure solutions using .NET, Java, PHP, Node.js, Python, or Ruby. Integrated Visual Studio tools enables you to quickly develop, debug and iterate apps.
- Save money and be agile
Per-minute billing and built-in auto scaling allows you to pay for only the infrastructure you really need and spin up/down resources automatically based on actual usage.
- Use what you already know with support from Microsoft
Start with the skills you already have and software you already know. Visual Studio, .NET, Window Server, Active Directory, SQL Server, SharePoint, and BizTalk work best with Azure and are all backed with end-to-end Microsoft enterprise support.
- Integrate on-premises apps and data
Securely manage cloud resources and enable your users to access apps using their existing corporate credentials with Active Directory.



hicloud S3

hicloud S3 is an Infrastructure as a service (IaaS) in Taiwan and provides unlimited storage for enterprises with RESTful API data transmission and management, and users only pay for what they use. By integrating a QNAP Turbo NAS and hicloud S3, enterprises can easily deploy the best remote replication and storage solution to diversify storage risks and save human & capital resources.

Features

- Perfect plan for business storage
No one can ensure that their data will be safe from equipment failures, nature disasters or other unpredictable factors. This has led to remote replication becoming an indispensable part of enterprise IT planning to avert risks.
- Multiple protection
The control room of hicloud S3 is ISO 27001 certified, and all the deployed equipment is based on HA (High Availability) architecture to minimize the risks of service interruption. To prevent data loss, hicloud S3 also stores 3 copies of user data and they are only retrieved via a unique, developer-assigned key, ensuring the most reliable cloud services for enterprises.



- Versatility and Flexibility
Enterprises can use hicloud S3 as a starting point for development and create various services and applications.



Ragic

Ragic is a cloud database platform designed particularly for small and medium enterprises. You can install tons of database applications including customer management, project management, and order tracking across all business functions for your small business with Ragic. Modify your applications anytime and customize them according to your own business needs with the quick and intuitive spreadsheet-styled UI to build your own cloud database. No coding skills are required.

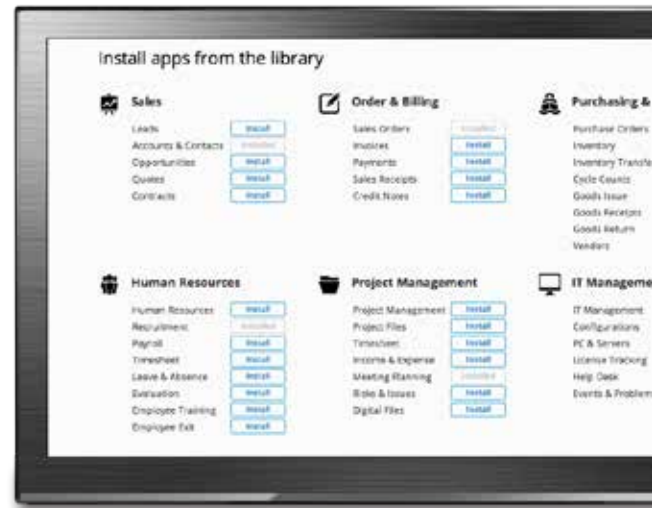

Features

- Get started with your database in minutes
Install the apps you want, build & modify them, and you're ready to get started.
- Modify your database the way you want
Add and remove fields at your own convenience, and shape your database structure according to your company's specific needs.
- Simple migration from spreadsheet applications
Type in your field names, and upload your data from Excel or other spreadsheet applications to Ragic, and you're ready for your database system. Ragic also supports formulas for calculations, and has many formatting options for the information to be displayed.
- Powerful search functions
Ragic's powerful search functions allow you to find anything with full text search, query criteria, and filtered views.
- Supports complex data relations
Link information from other sheets, and add sub-tables that automatically add information entered into another form. Simplify the process of data entry and have less duplicate information, allowing you to focus on your work.
- Set privacy and sharing options
With Ragic's user management system, assign your internal and external users to groups and set editing and viewing permissions.
- Tons of Developer Tools
Read and write data in Ragic from a complete HTTP API and run complicate queries with the server-side JavaScript scripting engine. Ragic gives you complete control over your applications.



Cloud M2M

Cloud M2M helps enterprises quickly deploy a private cloud fleet management platform. Through the mobile app, system administrators are notified of the real time status and locations of their employees & vehicles and can track their routes. As the system is constructed on a private cloud, the privacy and service reliability are maximized.



Features

- Total control over confidential data (location information, etc)
- Backend management system and vehicle monitoring in real time
- Location account management and user-defined driver fields
- Compatible with major mobile platforms (iOS and Android)
- Supports push notifications
- Wide range of reporting systems available on both smart phones and PCs
- Highly reliable, private and extremely scalable
- Exportable vehicle condition reports and customizable modules

References :
http://www.jareymobile.appspot.com/tw/product_list.html
http://www.qnap.com/dev/cht/p_demo1.php

TS-x53 Pro / SS-x53 Pro Series Hardware Introduction

Features

Intel Celeron® Quad Core processor

Powered by a quad-core Intel® Celeron® 2.0GHz processor (burst up to 2.41GHz), 2/4/8GB (expandable to 8GB) energy-efficient DDR3L RAM and dual/four LAN ports, the TS-x53 Pro/SS-x53 Pro is a powerful NAS with the highest-standard hardware that delivers unrivaled performance with up to 430MB/s read/write speeds. Also, with QvPC technology, the TS-x53 Pro/SS-x53 Pro can turn into a PC, making it a truly high value NAS.

Throughput (Quad-LAN Link Aggregation)

Windows Upload/Download, 5GB file,
IO Meter 8 worker settings

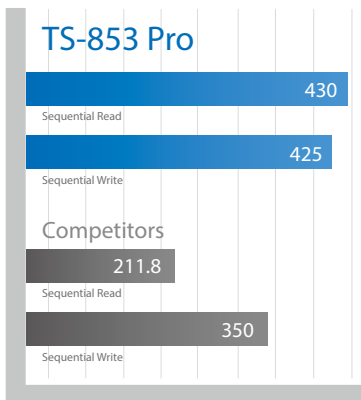

AES 256-bit Encryption

Windows Upload/Download, 5GB file

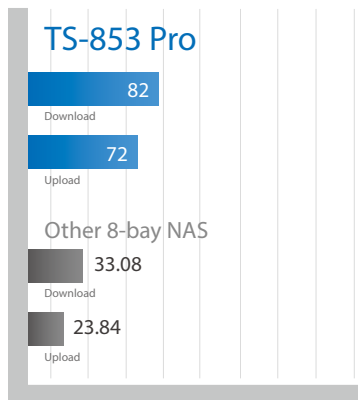

The TS-x53 Pro/SS-x53 Pro's fast encryption performance provides a transfer speed of up to 96MB/s with AES-256bit volume encryption that boosts system performance & security while ensuring the safety of personal sensitive data stored on the TS-x53 Pro/SS-x53 Pro.

Eco-friendly design

The TS-x53 Pro/SS-x53 Pro provides high performance with minimal power requirements and reduced heat generation with a cutting-edge 22nm processor and low-voltage, low-power DDR3L RAM. Other eco-friendly designs include scheduled power on/off, hard disk standby mode, and Wake on LAN.

Power Consumption

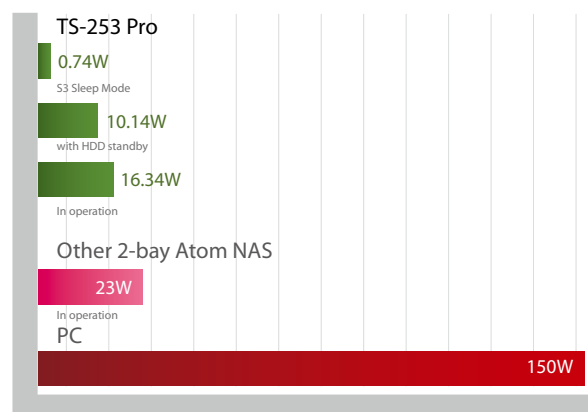

SSD cache acceleration

The SSD cache accelerates the IOPS performance and reduces I/O latency for the storage volumes*. It is perfect for IOPS-demanding applications such as virtualization in significantly improving overall workflow. The QTS cache technology adopts the Read Cache with Write Through algorithm and can greatly improve random read performance and ensure data security.

Faster data transfer speeds with 802.11ac Wi-Fi standard support

TS-x53 Pro/SS-x53 Pro supports the latest 802.11ac Wi-Fi standard. With a 802.11ac or 2.4GHz/5GHz dual-band USB Wi-Fi NIC, it can rapidly transmit large files and multimedia.



- **UX-800P / UX-500P**
The most economical way to expand your Turbo NAS storage

When expanding data storage, deploying multiple servers can lead to increased complexity in management and dramatically increased costs. The QNAP 8-bay UX-800P / 5-bay UX-500P expansion enclosure is a budget-friendly expansion alternative designed with easy setup in mind for expanding the total storage space of your Turbo NAS. The UX-800P offers a hassle-free storage expansion for home/small office use. The UX-800P provides space for an additional 8 hard drives for the Turbo NAS and allows for a total expansion raw capacity of 48 TB* making it especially useful for data backup, multimedia collections, and video surveillance.



Excellent hardware design - LCD panel

The UX series includes an internal 250W power supply to provide ample power even under sustained full load. The well-ventilated chassis and smart fan helps to provide efficient cooling for better stability and reliability, with the fan enabling efficient heat removal even when all drives are under full operation simultaneously.



Easily add additional capacity to a Turbo NAS

Simply connect a UX-800P / UX-500P to a Turbo NAS and power it on. The Turbo NAS will automatically detect the hard drives in the UX series as newly-installed local drives. The Turbo NAS capacity can then be expanded with an additional volume seamlessly by using the powerful QTS Storage Manager.

Flexible RAID configuration

The UX series features hot-swappable drive bays for easy installation and removal. The automatic insertion/removable detection and rebuild allows for easy management. Featuring RAID 0, 1, 5, 6 and 10 support and managed by the powerful QTS Storage Manager, the UX series ensures maximum performance and data security.

An excellent backup solution for Turbo NAS

The UX series can be used as a budget-friendly external storage to perform speedy and secure backup tasks for the Turbo NAS. The administrator can back up the Turbo NAS data to the UX series on a real time or scheduled basis.



Missing mode protection

If your UX series is accidentally disconnected, the Turbo NAS enters missing mode and blocks I/O access to the expansion enclosure to protect stored data. The system can then recover from missing mode to the normal state with data staying intact.

TS-x53 Pro / SS-x53 Pro Series Hardware Introduction

Eco-friendly design

The UX series automatically powers on/off with your Turbo NAS, allowing for total convenience and energy saving. The hard drives in the UX series can be configured to enter sleep mode after the system becomes idle after a preset period of time, extending their lifetime and saving you money on energy bills.

Powerful QTS Storage Manager

The QTS Storage Manager neatly presents tools and options for managing system storage with a modern & intuitive graphical user interface, which greatly simplifies the process of NAS capacity expansion and UX-800P/UX-500P management. No matter if you are an IT administrator or general user, you can easily monitor the status of UX-800P/UX-500P and the disks within it.

- Step 1: Connect the UX-800P/UX-500P to the NAS using USB 3.0.
- Step 2: Log in to the QTS Storage Manager.
- Step 3: Create new volumes and shared folders on the UX-800P/UX-500P.



QNAP USB 3.0 Expansion Enclosure



UX Expansion Enclosure	UX-500P	UX-800P
Supported HDD/SSD Types	5 x 3.5" or 2.5" SATA 6Gb/s,3Gb/s	8 x 3.5" or 2.5" SATA 6Gb/s,3Gb/s
Max. Number of HDDs and HDD Bays	5 hot-swappable HDDs and lockable bays	8 hot-swappable HDDs and lockable bays
RAID Management	Yes (using QNAP Storage Manager)	Yes (using QNAP Storage Manager)
USB Ports	1 x USB 3.0 (Back)	1 x USB 3.0 (Back)
LED Indicators	Power, network and status	Power, network and status
LCD Panel	Monochrome-LCD display (with backlight)	Monochrome-LCD display (with backlight)
Anti-theft Design	Kensington lock	Kensington lock
Fan	Silent fan x 1 (12 cm, 12V DC)	Silent fan x 1 (12 cm, 12V DC)
Power Supply Specification	Input: 100-240V AC, 50/60Hz, Output: 250W	Input: 100-240V AC, 50/60Hz, Output: 250W
Form Factor	Tower	Tower
Temperature	5°C ~ 35°C (40°F ~ 95°F)	5°C ~ 35°C (40°F ~ 95°F)
Humidity	5~95% RH; Web bulb: 27°C	5~95% RH; Web bulb: 27°C



The maximum raw storage capacity available by connecting QNAP expansion enclosures :

Turbo NAS Model	RAID Expansion Enclosure	No. of RAID Expansion Enclosure	Total HDD No.	Max. Raw Capacity (TB)
TS-1253U-RP	UX-1200U-RP	1	24 (12+12)	144
	UX-800U-RP	1	20 (12+8)	120
TS-853U-RP	UX-1200U-RP	1	20 (8+12)	120
	UX-800U-RP	1	16 (8+8)	96
TS-453U-RP	UX-1200U-RP	1	16 (4+12)	96
	UX-800U-RP	1	12 (4+8)	72
TS-853 Pro	UX-800P	1	16 (8+8)	96
	UX-500P	1	13 (8+5)	78
TS-653 Pro	UX-800P	1	14 (6+8)	84
	UX-500P	1	11 (6+5)	66
TS-453 Pro	UX-800P	1	12 (4+8)	72
	UX-500P	1	9 (4+5)	54
TS-253 Pro	UX-800P	1	10 (2+8)	60
	UX-500P	1	7 (2+5)	42
SS-853 Pro	UX-800P	1	16 (8+8)	56
	UX-500P	1	13 (8+5)	38
SS-453 Pro	UX-800P	1	12 (4+8)	52
	UX-500P	1	9 (4+5)	34

Note: A separate volume should be created on the UX-500P.

The maximum capacity is calculated by using 6TB hard drives (1TB for 2.5" hard drive.)

Accessories

Category		Order P/N	Description
RAM		RAM-2GDR3L-SO-1600	2GB DDR3L-1600 RAM Module SODIMM
RAM		RAM-4GDR3L-SO-1600	4GB DDR3L-1600 RAM Module SODIMM
RAM		RAM-8GDR3L-SO-1600	8GB DDR3L-1600 RAM Module SODIMM
QNAP Infrared (IR) Remote Control		RM-IR002	QNAP Infrared (IR) Remote Control

TS-x53 Pro / SS-x53 Pro Series Hardware Specifications



Turbo NAS Model	TS-253 Pro-8G TS-253 Pro	TS-453 Pro-8G TS-453 Pro	TS-653 Pro-8G TS-653 Pro	TS-853 Pro-8G TS-853 Pro	SS-453 Pro	SS-853 Pro
CPU	Quad-Core Intel Celeron 2.0 GHz (Burst up to 2.41 GHz)					
Memory (RAM)	TS-253 Pro-8G/ TS-453 Pro-8G/ TS-653 Pro-8G/ TS-853 Pro-8G: 8GB DDR3L				4GB DDR3L	
Max. memory amount	8 GB	8 GB	8 GB	8 GB	8 GB	8 GB
Flash	512MB (DOM)	512MB (DOM)	512MB (DOM)	512MB (DOM)	512MB (DOM)	512MB (DOM)
Number of RAM Slots	2	2	2	2	2	2
Max. number of HDDs/SSDs	2 x 2.5" or 3.5" SATA 6Gb/s, 3Gb/s HDD/SSD; hot-swappable	4 x 2.5" or 3.5" SATA 6Gb/s, 3Gb/s HDD/SSD; hot-swappable	6 x 2.5" or 3.5" SATA 6Gb/s, 3Gb/s HDD/SSD; hot-swappable	8 x 2.5" or 3.5" SATA 6Gb/s, 3Gb/s HDD/SSD; hot-swappable	4 x 2.5" SATA 6Gb/s, 3Gb/s HDD/SSD; hot-swappable	8 x 2.5" SATA 6Gb/s, 3Gb/s HDD/SSD; hot-swappable
Expansion Enclosure Support	1 (UX-500P, UX-800P)	1 (UX-500P, UX-800P)	1 (UX-500P, UX-800P)	1 (UX-500P, UX-800P)	1 (UX-500P, UX-800P)	1 (UX-500P, UX-800P)
Gigabit LAN Ports	2	4	4	4	2	4
USB	USB 3.0: 3 USB 2.0: 0	USB 3.0: 3 USB 2.0: 2	USB 3.0: 3 USB 2.0: 2	USB 3.0: 3 USB 2.0: 2	USB 3.0: 3 USB 2.0: 0	USB 3.0: 3 USB 2.0: 2
IR Sensor (MCE Remote)	Yes	Yes	Yes	Yes	Yes	Yes
HDMI	1	1	1	1	1	1
LED Indicators	Power/Status, USB, LAN, HDD1-2	Power/Status, USB, LAN, HDD1-4	Power/Status, USB, LAN, HDD1-6	Power/Status, USB, LAN, HDD1-8	Power/Status, USB, LAN, HDD1-4	Power/Status, USB, LAN, HDD1-8
Buttons	Power, Reset, USB Auto Copy	Power, Reset, USB Auto Copy	Power, Reset, USB Auto Copy	Power, Reset, USB Auto Copy	Power, Reset, USB Auto Copy	Power, Reset, USB Auto Copy
Dimensions (HxWxD)	150 x 102 x 216 mm 5.91 x 4.02 x 8.5 inch	177 x 180 x 235 mm 6.97 x 7.09 x 9.25 inch	175 x 257 x 235 mm 6.89 x 10.12 x 9.25 inch	185.2 x 298.2 x 235.4 mm 7.29 x 11.74 x 9.27 inch	150 x 102 x 216 mm 5.91 x 4.02 x 8.5 inch	185.2 x 298.2 x 235.4 mm 7.29 x 11.74 x 9.27 inch
Weight (Net/Gross)	Net weight: 1.74 kg (3.84 lbs) Gross weight: 2.92 kg (6.44 lbs)	Net weight: 3.65 kg (8.04 lbs) Gross weight: 4.65 kg (10.24 lbs)	Net weight: 5.2 kg (11.46 lbs) Gross weight: 6.5 kg (14.33 lbs)	Net weight: 7.3 kg (16.08 lbs) Gross weight: 8.6 kg (18.94 lbs)	Net weight: 3.84 kg (8.44 lbs) Gross weight: 2.92 kg (6.44 lbs)	Net weight: 3.97 kg (8.75 lbs) Gross weight: 4.97 kg (10.96 lbs)
Temperature and Humidity	0 - 40 °C, 5 - 95% RH					
Power Supply Specification	External Power Adapter, Output : 100-240V AC, 50/60Hz, Onput : 90W	250W ATX power supply; Output : 110-240 Vac-, 50-60Hz, 5A	250W ATX power supply; Output : 110-240 Vac-, 50-60Hz, 5A	350W ATX power supply; Output : 110-240 Vac-, 50-60Hz, 5A	External Power Adapter, Output : 100-240V AC, 50/60Hz, Output: 90W	250W ATX power supply; Output : 110-240 Vac-, 50-60Hz, 5A
Power consumption: HDD sleep mode	10.14 W	20.71 W	22.95 W	28.62 W	13.48 W	20.01 W
Power consumption: Typical operations (W)	16.34 W	33.13 W	41.65 W	59.54 W	20.83 W	32.27 W
Power consumption: NAS sleep mode (W)	0.74 W	0.80 W	1.09 W	1.08 W	0.75 W	0.78 W
File System: Internal Hard Drive	EXT4					
File System: External Hard Drive	EXT3, EXT4, NTFS, FAT32, HFS+					
RAID Recovery	Yes					
Online RAID Capacity Expansion	Yes					
Online RAID Level Migration	Yes					
RAID Type	Single Disk, RAID 0, RAID 1, RAID 5, RAID 6, RAID 10, RAID 5/6/10 + Spare, JBOD					
Global Hot Spare	No					
USB One-Touch-Copy Backup	Yes					
Surveillance Station - Default IP Cameras	2					
Surveillance Station - Max IP Cameras	24 (optional license purchase)					
VPN Server (PPTP + OpenVPN)	Yes					
Max. Number of Users	4096					
Max. Number of User Groups	512					
Max. Number of Shared Folders	512					
Max. Number of Concurrent Connections	700					

Software Specifications

Operating System

- QTS 4.1 (embedded Linux)

Supported Clients

- Windows 7 and Windows Server 2003 onward, Apple Mac OS X onward, Linux & UNIX

Supported Browsers

- Google Chrome
- Microsoft Internet Explorer 10+
- Mozilla Firefox
- Apple Safari

Multilingual Support

- Chinese (Traditional & Simplified), Czech, Danish, Dutch, English, Finnish, French, German, Greek, Hungarian, Italian, Japanese, Korean, Norwegian, Polish, Portuguese (Brazil), Romanian, Russian, Spanish, Swedish, Thai, Turkish

File System

- Internal hard drive: EXT4
- External hard drive: EXT4, EXT3, NTFS, FAT32, HFS+

Networking

- TCP/IP: IPv4 & IPv6**
- Dual/Quad Gigabit NICs with jumbo frame (failover, multi-IP settings, port trunking/ NIC teaming)
- Service binding based on network interfaces
- Proxy client, proxy server
- DHCP client, DHCP server
- NTP server
- Protocols: CIFS/SMB, AFP (v3.3), NFS(v3), FTP, FTPS, SFTP, TFTP, HTTP(S), Telnet, SSH, iSCSI, SNMP, SMTP, and SMSC
- UPnP & Bonjour discovery
- USB Wi-Fi adapter support

Security

- Network access protection with auto-blocking: SSH, Telnet, HTTP(S), FTP, CIFS/SMB, AFP
- CIFS host access control for shared folders
- FIPS 140-2 validated AES 256-bit volume-based data encryption*
- AES 256-bit external drive encryption*
- Importable SSL certificate
- Instant alert via E-mail, SMS, and beep
- Antivirus protection

Storage Management

- Online volume expansion
- Single Disk, JBOD, RAID 0, 1, 5, 6, 10, hot spare**
- Online RAID capacity expansion
- Online RAID level migration
- Storage expansion via QNAP UX-500P / UX-800P expansion unit (Max: 1 unit)
- Bad block scan and hard drive S.M.A.R.T.I.
- Bad block recovery
- RAID recovery
- Bitmap support

Power Management

- Wake on LAN
- Internal hard drive standby mode
- Scheduled power on/off
- Automatic power on after power recovery
- USB and network UPS support with SNMP management
- System sleep mode (S3)

Access Right Management

- Batch users creation
- Import/export users
- User quota management
- Local user access control for CIFS, AFP, FTP, and WebDAV
- Application access control for Photo Station, Music Station, Video Station, and Multimedia Station
- Subfolder permissions support for CIFS/SMB, AFP, FTP, and File Station

myQNAPcloud Service

- Private cloud storage and sharing with myQNAPcloud id (QID)
- Free host name registration (DDNS)
- Auto router (via UPnP) configuration
- Web-based file manager with HTTPS 2048-bit encryption

- Cloudlink for remote access without complicated router setup
- myQNAPcloud connect for easy VPN connection (Windows VPN utility)

Qsync

- Syncs files among multiple devices with SSL support
- Selective synchronization for syncing specific folders only
- Share team folder as a file center for team collaboration
- Shares files by links via e-mail
- Policy settings for conflicted files and file type filter support
- Version control: up to 64 versions.
- Incremental synchronization for HDD space saving
- Supports Windows & Mac OS

Web Administration

- Personalized desktop
- Smart toolbar and dashboard for system status
- Smart fan control
- Dynamic DNS (DDNS)
- SNMP (v2 & v3)
- Resource monitor
- Network recycle bin for file deletion via CIFS/SMB, AFP and File Station
 - Automatic cleanup
 - File type filter
- Comprehensive logs (events & connection)
- Syslog client/server
- Mobile app: Qmanager for remote system monitoring & management

File Server

- File Sharing across Windows, Mac, and Linux/UNIX
- Windows ACL
- Advanced folder permission for CIFS/SMB, AFP, FTP
- Shared folder aggregation (CIFS/SMB)

FTP Server

- FTP over SSL/TLS (explicit)
- FXP supported
- Passive ftp port range control

File Station

- Supports ISO Mounting (Up to 256 ISO Files)
- Support thumbnail display of multimedia files
- Support share download link and upload link
- Drag-n-drop Files via Chrome and Firefox Browsers
- Photo, music, and video preview and playback with hardware accelerated transcoding
- File Compression and decompression (ZIP and 7z)

Backup Station

- Remote replication server (over rsync)
- Real-time remote replication (RTRR) to another QNAP NAS or FTP server
- Works as both RTRR server & client with bandwidth control
- Real-time & scheduled backup
- Encryption, compression, file filter, and transfer rate limitation
- Encrypted replication between QNAP NAS servers
- Desktop backup with QNAP NetBak Replicator for Windows
- Apple Time Machine backup support
- Data backup to multiple external storage devices
 - Third party backup software support: Veeam backup & replication, Acronis True Image, Arcserve backup, EMC retrospect, Symantec Backup Exec, etc.

Cloud Storage Backup

- Amazon S3
- Amazon Glacier
- WebDAV-based cloud storage
- Microsoft Azure
- Open Stack
- Google Drive
- Dropbox

ElephantDrive

- Symform

Print Server

- Max number of printers: 3
- Print job display and management
- IP-based and domain name-based privilege control

Virtualization Station

- Support Virtual Machine (VM) creation to run an operating system such as Windows, Linux, Unix and Android
- Support importing VM from the other virtual platform, e.g. VirtualBox, VMware Workstation
- Support exporting VM with *.ovf, *.qvm formats
 - VM clone
 - VM snapshot
- HTML5-based shared remote console
- User-based permission setting
- Support USB device pass-through
- Support VM console display via HDMI

Signage Station

- Support dynamic content includes video, image, music, and text message
- Multi-user collaboration
- Support email and social network sharing
- Support design software - iArtist Lite for Windows®
- Support various browser playback (Chrome, Firefox, IE, Safari)
- Support most viewed, latest released and different categories content list

iSCSI (IP SAN)

- iSCSI Target
- Multi-LUNs per Target
- Up to 256 Targets/LUNs Combined
- Supports LUN Mapping & Masking
- File-based LUN
- Online LUN Capacity Expansion
- Supports SPC-3 Persistent Reservation, MPIO, MC/S
- iSCSI LUN Backup, One-time Snapshot, and Restore
- iSCSI Connection and Management by QNAP Finder (Windows)
- Virtual Disk Drive (via iSCSI Initiator)
- Max No. of Virtual Disk Drives: 8

Server Virtualization & Clustering

- Server Virtualization & Clustering
- VMware vSphere (ESXi 5.5)
- VMware VAAI for iSCSI and VAAI for NAS
- vSphere Plug-in
- Citrix XenServer (6.2)
- Windows Server 2012 R2 Hyper-V
- Supports Microsoft ODX
- QNAP SMI-S provider for Microsoft SCVMM

Transcode Management

- Transcode video files to 240p, 360p, 480p, 720p and 1080p resolution
- Automatic video transcoding for watched folders
- Hardware accelerated transcoding support

Surveillance Station

- Supports over 2,700 IP cameras
- Includes 2 free camera licenses, up to 24 camera channels via additional license purchase
- Instant playback to check the recent event
- Online editing to edit cameras when live view
- Visual aid by e-map
- Playback and speed control by shuttle bar
- Video preview on playback timeline
- Intelligent video analytics (iva) for advanced video search
- Surveillance client for Mac
- Mobile surveillance app: vmobile (iOS and Android)
- Mobile recording app: vcam (iOS and Android)

Notes Station

- Graphical web-based editor for taking notes
- Integrate with NAS file system: insert attachment or image from NAS file system

- Event calendar and to-do list
- Image editor: a easy way to highlight the focus in your image
- Support note publishing with a single link
- Support key word search
- Provide Chrome Extension: Notes Station Clipper
- Clip web page content to your note
- Mobile app: Qnotes

VPN Server

- Secure remote access: PPTP & OpenVPN VPN services
- Max number of clients: 15 for PPTP & 15 for OpenVPN

Domain Authentication Integration

- Microsoft Active Directory (AD)
- Domain controller
- LDAP server, LDAP client
- Domain users login via CIFS/SMB, AFP, FTP, and File Station

App Center

- More than 100 official and community software add-ons (ex: Dropbox, Google Drive Sync, McAfee, WordPress, HappyGet II, etc.)
- Photo Station
- Music Station
- Video Station
- iTunes Server
- DLNA Server
- AirPlay: Streams videos, photos and music from NAS to Apple TV via Qfile or QAirPlay's web-based controller
- Digital TV Station
- DVB-T Digital TV Live View, Recording, and Playback
- Supports up to 2 USB TV Tuners
- Electronic Programming Guide (EPG) with Scheduled Recording
- Note: The availability of DVB-T broadcasting and EPG may vary depending on geographic locations.
- Download Station
- HD Station + XBMC media player + Google Chrome

Mobile Apps

- Qfile: iOS, Android, Windows Phone 8+
- Qfile HD: iPad version
- Qmanager: iOS, Android
- Qmusic: iOS, Android
- Qremote: iOS, Android
- Qget: Android
- Vmobile: iOS, iPad, Android

- * The data encryption functions may not available in accordance with the legislative restrictions of some countries.
- ** Not all services and features are supported.

Design and specifications are subject to change without notice.

With Intel Quad-Core
Celeron® 2.0GHz

Goodbye Atom®, Hello Celeron®
with HDMI & Virtualization

QvPC Technology

Supreme Value Great Performance

- Real-time/offline transcoding
- World's first NAS with built-in
 - QvPC Technology
 - Intuitive QTS 4.1
 - Cloud print server
- Online file editing & sharing
- Supports up to 8GB DDR3L RAM
- Super performance with four GbE LAN ports
- Fast 430MB/s read/write speeds



All New Turbo QNAP NAS TS-853 Pro / TS-653 Pro

QvPC Technology



- Use your NAS as a PC
- Integrated XBMC Media Player
- HDMI Output for recordings playback
- Streamlined installation

Virtualization Station



- Supports Windows, Linux and UNIX
- Import/Export VMs
- Snapshots for backup & restore
- Compatible with VM markets

Hardware-accelerated Transcoding



- On-the-fly & offline transcoding
- Auto/Manual media conversion
- VOD streaming
- Compatible with multi-device

QNAP Systems, Inc.

TEL : +886-2-2641-2000 FAX : +886-2-2641-0555 Email: qnapsales@qnap.com
Address : 3F, No.22, Zhongxing Rd., Xizhi Dist., New Taipei City, 221, Taiwan

QNAP may make changes to specification and product descriptions at any time, without notice. Copyright © 2014 QNAP Systems, Inc. All rights reserved.

QNAP® and other names of QNAP Products are proprietary marks or registered trademarks of QNAP Systems, Inc. Other products and company names mentioned herein are trademarks of their respective holders.

Celeron is a trademark of Intel Corporation in the U.S. and/or other countries.

Netherlands (Warehouse Services)
Email: nlsales@qnap.com
TEL: +31 (0) 107600830

Germany
Email: desales@qnap.com
TEL: +49-89-381562991

China
Email: cnsales@qnap.com
TEL: +86-400-628-0079

India
Email: indiasales@qnap.com

US
Email: usasales@qnap.com
TEL: +1-909-595-2782



P/N: 51000-023629-RS
201409 (EN)C